



KERR WOOD LEIDAL
consulting engineers

Greater Vancouver
200 - 4185A Still Creek Drive
Burnaby, BC V5C 6G9
T 604 294 2088
F 604 294 2090

Water Distribution Master Plan

Final Report
November, 2016
KWL Project No. 173.164-300

Prepared for:



MAPLE RIDGE
BRITISH COLUMBIA



Contents

Executive Summary i

1. Introduction 1-1

1.1 Overview 1-1

1.2 Work Program..... 1-1

1.3 Abbreviations Used..... 1-1

1.4 Referenced Material 1-2

1.5 Acknowledgements..... 1-3

2. Existing System Overview 2-1

2.1 Summary 2-1

2.2 Metro Vancouver Supply 2-1

2.3 Pressure Zones 2-1

2.4 Serviceable Elevations 2-4

2.5 Existing Facilities 2-5

3. Water Model Update 3-1

3.1 Summary of Model Build 3-1

3.2 Water Main Update 3-1

3.3 Facility Update..... 3-1

4. Residential Populations and Land Use..... 4-1

4.1 Data Sources 4-1

4.2 Residential Population Distribution Methodology..... 4-1

4.3 Future Land Use 4-2

5. Existing Demands..... 5-1

5.1 Introduction 5-1

5.2 Source Data 5-1

5.3 Data Quality Control..... 5-1

5.4 Existing Water Balance..... 5-2

6. Future Demands 6-1

6.1 Base Demand..... 6-1

6.2 Seasonal Demand 6-3

6.3 Water Conservation 6-4

6.4 Diurnal Patterns..... 6-4

6.5 Summary of Future Demands 6-4

7. Pressure Validation 7-1

7.1 Introduction 7-1

7.2 240 Street Corridor Validation/Calibration..... 7-1

7.3 Pressure Validation (Attempt No. 2)..... 7-2

8. Design Criteria 8-1

8.1 Boundary Conditions..... 8-1

8.2 Pump Station Capacity 8-1

8.3 Required Reservoir Storage..... 8-2

8.4 Pressure 8-2



8.5	Fire Flow.....	8-2
8.6	Water Mains	8-2
8.7	Pump Stations	8-2
9.	Cost Opinions	9-1
9.1	Unit Rates.....	9-1
10.	Evaluation of System.....	10-1
10.1	Summary	10-1
10.2	Reservoir Storage Volumes	10-1
10.3	Pump Station Capacities	10-3
10.4	Hydraulic Model Analysis.....	10-4
10.5	Redundancy Review	10-6
10.6	Miscellaneous Review Items.....	10-6
11.	Water System Capital Projects	11-1
11.1	Reservoir Storage Projects	11-1
11.2	Pump Station Projects.....	11-3
11.3	Linear Infrastructure and PRV Projects.....	11-4
11.4	Upgrades to Increase Redundancy	11-6
11.5	Miscellaneous Water System Improvements	11-8
11.6	Silver Valley Servicing.....	11-8
11.7	Thornhill Urban Reserve Servicing	11-12
11.8	Albion Flats Densification	11-15
11.9	Kwantlen First Nation	11-16
11.10	Possible OCP Densification.....	11-17
12.	Recommended Master Plan.....	12-1
12.1	Scope of Master Plan.....	12-1
12.2	Recommendations	12-1
12.3	Report Submission	12-2

Figures

Figure 2-1: Existing Maple Ridge Water System.....	2-6
Figure 2-2: Maple Ridge Supply Existing System Schematic.....	2-7
Figure 2-3: Maximum Ground Elevation by Pressure Zone.....	2-8
Figure 5-1: BD-Res Diurnal Pattern	5-7
Figure 5-2: BD-ICI Diurnal Pattern	5-8
Figure 5-3: SD-RES Diurnal Pattern	5-8
Figure 5-4: SD-ICI Diurnal Pattern	5-9
Figure 5-5: Comparison Between Modelled and SCADA Demands.....	5-10
Figure 5-6: Base Demands	5-11
Figure 5-7: Seasonal Demands.....	5-12
Figure 5-8: City of Maple Ridge Water Model Demand Summary – Existing (Actual).....	5-13
Figure 5-9: City of Maple Ridge Water Model Demand Summary – Existing (Design)	5-14
Figure 6-1: City of Maple Ridge Water Model Demand Summary – Future (2041)	6-6
Figure 7-1: Pressure Monitoring Locations.....	7-4
Figure 10-1: Peak Hour Demand Pressures – Existing (Design) System	10-7
Figure 10-2: Available Fire Flow – Existing (Design) System.....	10-8



Figure 10-3: Static (Nighttime) Pressures – Existing (Design) System 10-9
 Figure 10-4: Peak Hour Demand Pressures – 2018 System 10-10
 Figure 10-5: Available Fire Flow – 2018 System 10-11
 Figure 10-6: Peak Hour Demand Pressures – 2023 System 10-12
 Figure 10-7: Available Fire Flow – 2023 System 10-13
 Figure 10-8: Peak Hour Demand Pressures – 2041 System 10-14
 Figure 10-9: Available Fire Flow – 2041 System 10-15
 Figure 11-1: Capital Tasks to Address Existing Concerns and Short-Term Growth 11-18
 Figure 11-2: Capital Tasks to Address Future Growth 11-19
 Figure 11-3: Peak Hour Pressures with Upgraded System and Year 2041 Demands 11-20
 Figure 11-4: Available Fire Flow with Upgraded System and Year 2041 Demands 11-21

Tables

Table 2-1: Summary of Serviceable Elevations by Pressure Zone 2-4
 Table 5-1: Design Demand Rates 5-6
 Table 6-1: Future BD-Res 6-1
 Table 6-2: Future BD-ICI – Top Fifth Percentile Large Users 6-2
 Table 6-3: Future BD-ICI – Average Users 6-2
 Table 6-4: Future NRW 6-3
 Table 6-5: Future SD-Res 6-3
 Table 6-6: Future SD-ICI – Top Fifth Percentile Large Users 6-3
 Table 6-7: Future SD-ICI – Average Users 6-4
 Table 6-8: Comparison of Existing and Future MDD by Zone 6-5
 Table 7-1: Summary and Comparison of PH SCADA Pressures to Water Model Pressures 7-5
 Table 7-2: Summary and Comparison of Nighttime SCADA Pressures to Water Model Pressures 7-6
 Table 8-1: Required Fire Flow by Land Use Zoning Type 8-2
 Table 9-1: Unit Rates for Cost Opinions 9-1
 Table 10-1: Summary of Reservoir Volumes (Existing and MMCD Design) 10-2
 Table 10-2: Storage Reservoir Notes 10-2
 Table 10-3: Summary of Pump Station Capacities 10-3
 Table 10-4: Pump Station Notes 10-4
 Table 10-5: Hydraulic Assessment Notes 10-5
 Table 10-6: Redundancy Notes 10-6
 Table 10-7: Other Review Items 10-6
 Table 11-1: Reservoir Projects 11-2
 Table 11-2: Pump Station Projects 11-3
 Table 11-3: Linear Infrastructure and PRV projects 11-4
 Table 11-4: Upgrades to Increase Redundancy 11-6
 Table 11-5: Miscellaneous Water System Improvement 11-8
 Table 11-6: Upgrades within the Silver Valley Area 11-10
 Table 11-7: Capital Projects for Conveying Water to Thornhill 11-14
 Table 11-8: Capital Projects for Albion Flats Servicing 11-15
 Table 11-9: Upgrades Required for Kwantlen First Nation Servicing 11-16
 Table 11-10: Possible Densification Demand Summary 11-17
 Table 11-11: Comparison of OCP With and Without Optional Densification 11-17
 Table 12-1: Capital Plan Cost Summary 12-1



Appendices

- Appendix A: Summary of Existing Facilities
- Appendix B: Water Main Piping Inventory and Model Output
- Appendix C: 240 Street Flow Testing Results (Email)
- Appendix D: Pressure Validation Data
- Appendix E: Supply and Storage Sizing Calculations
- Appendix F: Hydraulic Assessment Notes
- Appendix G: Detailed Capital Projects Tables
- Appendix H: Maple Benchlands Area



Executive Summary

Kerr Wood Leidal Associates Ltd. (KWL) was retained by the City of Maple Ridge (City) to update their Water Distribution Master Plan. The Water Distribution Master Plan summarizes the servicing approach and projects associated with serving the community to the year 2041.

KWL's scope of work included:

1. updating the City's hydraulic water model to reflect current conditions;
2. estimating water demands for existing conditions, as well as for years 2018, 2023, and 2041;
3. validating the water model using field pressure and flow data;
4. conducting a hydraulic analysis of the system to determine system pressures, flows, and available fire flow for existing and future conditions;
5. identifying constraints to meeting performance objectives as defined by the City's Design Criteria Manual for existing and future development conditions;
6. developing capital projects to meet servicing objectives through 2041;
7. developing budget level cost estimates for identified capital projects; and
8. preparing a Master Plan which outlines projects, costs, and priorities.

Population distributions provided by the City were used as the basis for estimating existing and future water demands. Flow records for MV bulk meters and City service meters were used to prepare an existing demand build, separated into various residential and industrial, commercial, and institutional (ICI) uses. Water use unit rates were derived based on existing demands and populations, which were then used to estimate future demands.

Possible future large-scale developments were considered as additional demands beyond those estimated for the 2018, 2023, and 2041 scenarios. The Thornhill Urban Reserve, Kwantlen First Nation, and Albion Flats areas will, if development proceeds, add significant demand to the southeast region of Maple Ridge (the 240 Street Corridor), primarily impacting the 84 m Centre and Albion Zones. Further, in anticipation of growth beyond that defined in the OCP for specific areas, a 'possible densification' scenario was also considered.

Capital projects are proposed to address the categories of storage, pumping, hydraulics and redundancy. Capital cost opinions are provided for each project, to allow for long-range planning. Below is a summary of the capital works identified.

Category	Total Cost
Short Term Growth	\$7,120,000
Future Growth	\$10,920,000
Thornhill Urban Reserve Projects	\$17,560,000
<small>Note: Thornhill cost allows for servicing to Thornhill, but not distribution within Thornhill.</small>	

Note that servicing costs for Albion Flats and KFN are not included in this summary, as they relate to as of yet unapproved development (not currently part of the OCP). Total costs also do not include rehabilitation/replacement associated with asset management programs.



1. Introduction

1.1 Overview

Kerr Wood Leidal Associates Ltd. (KWL) was retained by the City of Maple Ridge (the City) to update its Water Distribution Master Plan in 2014. The Master Plan summarizes the upgrades required to maintain an adequate level of service to the year 2041. The Master Plan was previously updated in 2011.

1.2 Work Program

The work completed as part of the master plan update includes:

- updating the City's water system computer model, including adding newly constructed water mains and updating facility information;
- preparing an updated existing demand build and loading it into the model;
- validating the existing water system model demands and pressures with field data;
- estimating future populations and service area growth based on planning data provided by the City;
- estimating future water demands for the years 2018, 2023 and 2041;
- conducting a hydraulic analysis of the water distribution system to determine system pressures, flows and available fire flows for existing and future conditions;
- developing water distribution system upgrades to address existing and future water service requirements;
- developing budget level cost estimates for identified upgrade projects; and
- preparing a Master Plan which outlines projects, projects costs and priorities.

1.3 Abbreviations Used

BD	Base Demand (average winter demand)
City	City of Maple Ridge
GD	Geodetic Datum
HGL	Hydraulic Grade Line to Geodetic Datum
hp	Horsepower
ICI	Industrial, Commercial, and/or Institutional Demands
L/s	Liters per second
MDD	Maximum Day Demand (peak daily demand, typically summer)
ML	Mega-Litre
MV	Metro Vancouver
PE	Population Equivalent
PRV	Pressure Reducing Valve
MLD	Million Liters per Day
NRW	Non-Revenue Water
RES	Residential Demands
SD	Seasonal Demand (increase in demands during summer = MDD – BD)
TWL	Top Water Level



1.4 Referenced Material

Preparation of the report has proceeded with the benefit of the following reference materials and data:

1. City of Maple Ridge GIS data including connected parcels (to the water system), meter records for 2009 and 2013, parcel land use codes, and water system drawings;
2. City of Maple Ridge SCADA flow and pressure records for 2013, and various other water system data;
3. City of Maple Ridge, Bentley WaterCAD v8i hydraulic system model;
4. Metro Vancouver, SCADA records for 2009 and 2013 including flow into Maple Ridge via the Haney Mains and Metro Vancouver Maple Ridge Reservoir levels;
5. AECOM 2018, 2023, and 2041 City of Maple Ridge projected population models;
6. City of Maple Ridge, *Maple Ridge Official Community Plan Bylaw No. 7060-2014*, 2014;
7. KWL, *Water Distribution Master Plan*, March 2011, KWL file #173.136;
8. KWL, *Technical Memorandum Re: Albion Flats Development – Water Servicing*, September 2010, KWL file #173.138;
9. KWL, *Technical Memorandum Re: Silver Valley Water Zoning Options*, April 2003, KWL file #173.012;
10. KWL, *Technical Memorandum Re: Kwantlen First Nations Water Servicing*, July 2011, KWL file #173.142;
11. KWL, *Technical Memorandum Re: Maple Benchlands Servicing – Water Servicing Review*, August 2013, KWL file #173.156;
12. Urban Systems / GeoAdvice, *138 m and 241 m Zone Storage and Optimization Study*, October 2013; and
13. Urban Systems, *Thornhill Conceptual Water Servicing Strategy*, May 2014.



1.5 Acknowledgements

The project team for this study included the following individuals:

City of Maple Ridge

Joe Dingwall, P.Eng.	Manager of Utility Engineering
George Irwin	Geomatics Supervisor
Davin Wilson	Superintendent of Waterworks
Mike Gjaltema	Electrical / Mechanical Manager

Kerr Wood Leidal Associates Ltd.

Michelle Revesz, P.Eng.	Project Manager
John Delver, P.Eng.	Project Manager
Eric Morris, M.A.Sc., P.Eng.	Technical Reviewer
Jonathan Funk, P.Eng.	Project Engineer
Mike Miller, P.Eng.	Project Engineer
Alfred Louie, E.I.T.	Project Engineer
Ryan Taylor, GISP	GIS Professional
Tiffany Soh, B.Sc.	GIS Analyst

Metro Vancouver

Guy Roberts, P.Eng.	Senior Project Engineer
Farshad Mortazavi	SCADA Data Support
Jessica Holman	Hydrologic Technician



2. Existing System Overview

2.1 Summary

The existing Maple Ridge water distribution system consists of 13 pressure zones, eight storage reservoirs, eight pump stations, 29 PRV stations, and approximately 418 km of water main.

The City receives treated water from the Metro Vancouver (MV) transmission system via Haney Mains #2 and #3. The existing water system is presented on Figure 2-1 and is described in detail in the following sections.

2.2 Metro Vancouver Supply

The City is supplied by Metro Vancouver from the Coquitlam Reservoir Source via Haney Mains #2 and #3 to the City's western boundary. Within the City, MV owns the Maple Ridge Reservoir (246 Street Reservoir), which provides balancing storage (to reduce peak flows in MV transmission mains), and a level of redundancy (if supply from the transmission system to the west is disrupted). The 246 Street Reservoir is supplied via the Dewdney Trunk Road section of Haney Main #2, the 232 Street Connector, and the new Maple Ridge Main.

MV's supply agreement with the City states that MV must maintain a minimum HGL of 84 m at Dewdney Trunk Road and 230 Street. Figure 2-2 shows a schematic of the existing system along with the completed Maple Ridge Main and planned connections. The figure also includes PRV set points, pump set points, pump station flows, reservoir volumes/levels, and zone demands.

2.3 Pressure Zones

Summary

The pressure zones in the City are described in detail in the following sections; the pressure zones are shown on Figure 2-1. The typical supply hydraulic grade line (HGL) is shown at the beginning of each zone name.

84 m Centre Zone (Including 96 m 232 Street Sub-zone)

The 84 m Centre Zone has the highest water demand in the City's system. It is supplied via MV's transmission main from several PRV stations situated on Dewdney Trunk Road.

As previously mentioned, MV has agreed to maintain a minimum 84 m HGL in this zone specifically at Dewdney Trunk Road and 230 Street.

During times of high demand, balancing storage is supplied by MV's 23,000 m³ Maple Ridge Reservoir, also known as the 246 Street Reservoir (TWL 96 m GD) at 246 Street and Dewdney Trunk Road.

In addition to this, the 96 m 232 Street zone exists as a sub-zone within the 84 m zone that is fed directly from MV (not pressure regulated). The 96 m zone is geographically located within the Silver Valley area and is connected to the MV transmission system by a feeder main on 232 Street.



176 m Rockridge/Silver Valley Zone

The Rockridge Zone includes single and multi-family residential housing in the eastern portion of Silver Valley. The zone is bounded by the North Alouette and South Alouette Rivers, generally between 232 Street and 240 Street. Its maximum service elevation is approximately 130 m.

The zone is gravity fed by the 1,400 m³ Rockridge Reservoir (TWL 177.8 m GD) with the 236 Street Pump Station (capacity 68 L/s) filling the reservoir by pumping from the 96 m 232 Street Subzone. These facilities also serve as supply and balancing storage to associated sub-zones (i.e., 140 m Lower Silver Valley Zone, 122 m Fern Zone, and future 210 m Forest Zone).

It is noted that future growth in the northwest portion of Silver Valley (west of the North Alouette River) will be directly connected to the Rockridge Zone, forming the 176 m Upper Silver Valley Zone.

122 m Fern Zone

This zone primarily contains single-family residential lots. It is supplied from the 176 m Rockridge Zone via PRV stations at 235 Street, 236 Street, 237 Street, and 239B Street on 132 Avenue.

Another connection exists from the 134 m East Zone, via PRV-241. This connection is normally closed but was the Fern Zone's primary supply point in the past.

Balancing and fire flow storage is provided by the Rockridge Reservoir (TWL 177.8 m GD, 1,400 m³ capacity).

140 m Lower Silver Valley Zone

As with the Fern Zone, the 140 m Lower Silver Valley Zone is a sub-zone of the Rockridge Zone. It was formed to service new developments along 232 Street north of 136 Avenue and is normally supplied from the 175 m Rockridge Zone via PRV. The zone can also be serviced by the 232 Street Pump Station, which is capable of providing domestic flows only, not fire flow. Fire flows for the zone are provided from the 176 m Rockridge Reservoir via the 232 Street PRV Station (within the 232 Street Pump Station).

210 m Forest Zone

The creation of the future 210 m Forest Zone will be dependent on development progressing above approximately 130 m elevation in northeast Silver Valley.

The area is zoned for single-family residential housing, and the ground elevations would make the construction of a reservoir to service the area very difficult since available elevation is limited and constrained by the UBC Research Forest to the north. Because of this, we suggest that the area be serviced with a fire pump station rather than a pump and reservoir.

158 m Albion Zone and 112 m Albion Sub-zone

The 112 m Albion Sub-zone is serviced directly from this zone through the 245B Street and 104 Avenue PRV station. The Albion Pump station (firm capacity 47 L/s) supplies the 158 m Albion Zone from the 84 m Centre Zone via the 400/500 mm diameter 240 Street transmission main, while the two-celled Albion Reservoir (TWL 158 m GD, 1,290 m³ capacity) provides balancing, fire, and emergency storage.



224 m Grant Mountain Zone and 158 m Lower Grant Zone

The 224 m Grant Mountain Zone is located on the south side of 112 Avenue generally between 252 Street and 256 Street. The zone was created in 2013 and much of the zone is still under development. It is supplied by the Grant Mountain Reservoir, a concrete reservoir with a TWL of 224 m GD.

The reservoir is supplied by the Grant Mountain Pump Station (firm capacity of 19 L/s), which pumps from the 134 m East Zone. The pump station includes a hypochlorite injection system to boost chlorine levels before entering the dedicated Grant Mountain Reservoir supply line.

The 158 m Lower Grant Mountain Zone is supplied by the 224 m Grant Mountain Zone via two PRV stations. One is located within the Grant Mountain Pump Station, while the second is a buried chamber at 112 Avenue and 252 Street. The pressure settings of the stations are set such that only the 252 Street PRV Station is active at lower flows. The 158 m Lower Grant Mountain Zone is planned to ultimately become part of the 158 m Albion Zone as development in the Albion area progresses north and connects at 252 Street.

138 m East Zone

The 138 m East Zone is comprised of developed land between 240 Street and 260 Street. Elevations vary from 50 m to 102 m. The 263 Street Reservoir (TWL 137.8 m GD, 2,200 m³ capacity) provides balancing, fire, and emergency storage and the zone is supplied by the 246 Street Pump Station.

241 m NE Zone (North and South)

The Northeast (NE) zone was two separate zones prior to 2005, as a result it is serviced by two reservoirs (256 Street and 270A Street) and two pump stations (256 Street and 263 Street). The zone is predominately comprised of single-family residential lots with some limited institutional and industrial land use at the north end of 256 Street, as well as the Kanaka Business Park.

The zone's northern portion is supplied via the 256 Street Pump Station while the 256 Street Reservoir (TWL 241 m GD, capacity 2,532 m³ between two cells) provides balancing, fire, and emergency storage.

The zone's southern portion is supplied by the 263 Street Pump Station (32 L/s firm capacity) while the 270A Street Reservoir (TWL 241 m GD, 600 m³ capacity) provides balancing, fire, and emergency storage.

Residual chlorine concentrations are maintained through the re-chlorination stations installed at the 256 Street and 263 Street Pump Stations.

171 m 130 Avenue Zone

The 171 m 130 Avenue Zone services single-family lots along 130 Avenue between 250 Street and 256 Street where elevations range between 100 m and 110 m. The 241 m NE Zone provides the primary supply through the 256 and 130 Avenue PRV and Pump Station (31 L/s firm capacity). Balancing, fire, and emergency storage are provided by the 256 Street Reservoir (TWL 241 m GD, capacity 2,532 m³).

171 m Tretheway Zone

The 171 m Tretheway Zone consists of low-density residential properties on the eastern side of the City and is situated between the 134 m East Zone and 241 m NE Zone. It includes lots on 261 Street north of Dewdney Trunk Road and lots on Dewdney Trunk Road between 261 and 263 Street. The 270A Street Reservoir (TWL 241 m GD, capacity 600 m³) provides balancing and fire flow storage via the DTR and 263 PRV Station, while supply to the reservoir is delivered by the 263 Street Pump Station.



329 m Garibaldi Zone

The 329 m Garibaldi Zone has the highest HGL of all the pressure zones, and is located in the northwest area of the City. Balancing, fire, and emergency storage is provided by the McNutt Reservoir (TWL 329.6 m GD, 633 m³ capacity), which is filled via the 270A Pump Station (16 L/s firm capacity).

293 m Rothsay Zone

The 293 m Rothsay Zone is supplied by the 329 m Garibaldi Zone through the McNutt Road and 12400 PRV Station.

2.4 Serviceable Elevations

Maximum ground elevations and estimated maximum serviceable elevations (based on an assumed headloss allowance and maintaining a minimum pressure of 44 psi during peak hour demand) for each pressure zone are summarized in Table 2-1 below. The location of the potential future maximum serviced elevations are shown on Figure 2-3.

It is noted that the highest elevations within the area for several pressure zones show as being significantly higher than what the existing zone can adequately service. Typically, the future road network and individual lots are not defined at this time; therefore, the highest ground elevation reported may not be reflective of final lot grades (e.g., a parcel may slope upwards significantly from a future road frontage, resulting in a higher elevation in comparison to the lot area likely to be developed). The information below should be used as a guide for estimating serviceable elevations for new developments, and the final details should be determined with a water servicing review.

Table 2-1: Summary of Serviceable Elevations by Pressure Zone

Zone Name	Max. Serviceable Ground Elevation (m GD) ¹	Existing Max. Serviced Ground Elevation (m GD)	Future Max. Ground Elevation in Zone (m GD) ²	Comment on Existing Maximum Serviced Ground Elevation
84 m Centre	44	57	60	Note that 44m is a calculated value based on a rule of thumb formula allowing for reservoir draw down and system losses. In this zone, ground elevations around Dewdney Trunk Road between 228 Street and 240 Street are typically 55 m GD. The PRV station set points in this area are typically higher than 84 m and connect to Metro Vancouver transmission supply, which does not draw down. Proximity to supply sources within the zone is also a factor when determining actual serviceable elevations.
96 m 232 HP Centre Subzone	56	49	68	No issues noted for existing conditions.
122 m Fern	82	86	101	Highest ground elevation at the east end of 132 Avenue, past 237A Street. Existing PHD design pressure is 48 psi.







Zone Name	Max. Serviceable Ground Elevation (m GD) ¹	Existing Max. Serviced Ground Elevation (m GD)	Future Max. Ground Elevation in Zone (m GD) ²	Comment on Existing Maximum Serviced Ground Elevation
138 m East	98	108.5	119	Highest ground elevations are near the 263 St. Reservoir, and the intersection of Dewdney Trunk Road and 260 Street; therefore, minimal pipe loss is expected and actual serviceable elevation for this area is higher.
140 m Silver Valley West	100	98	96	No issues noted for existing conditions.
158 m Albion	118	124.3	111	Highest ground elevations are near the Albion Reservoir, at the intersection of 104 Avenue and 248 Street; therefore, pipe headloss in the area is minimal and existing servicing pressures are acceptable.
171 m 130 Ave.	131	111.1	145	No issues noted for existing conditions.
171 m Tretheway	131	123.8	134	No issues noted for existing conditions.
176 m Silver Valley	138	136	140	No issues noted for existing conditions.
224 m Grant Mountain	184	172.8	178	No issues noted for existing conditions.
241 m NE	201	205.7	214	Highest elevation at the northern end of 269 Street. Existing design PHD pressure is 44 psi.
293 m Rothsay	253	238.4	257	No issues noted for existing conditions.
329 m Garibaldi	290	295	303	Highest ground elevations are located at 128 Avenue and Garibaldi Street. Existing design PHD pressure is 45 psi.
Notes:				
1. Maximum serviceable elevation is based on the zone static HGL (i.e. reservoir TWL) minus 40 m to allow for pipe headlosses, reservoir drawdown, and to maintain a minimum pressure of 44 psi during PHD.				
2. Future maximum ground elevation is estimated using contours and the full extent of the potential future servicing area; actual serviced area should be determined through servicing reviews.				

2.5 Existing Facilities















The details of each existing reservoir, pump station, and PRV station are included in the tables in Appendix A. The tables include the key elevations, set points, diameters, etc. that were included in the water model.

City of Maple Ridge Water Distribution Master Plan

Legend

-  Existing Transmission Main (MV) (≥600 mm)
-  Existing Watermain (in Water Model)
-  Existing Booster Pump Station
-  Existing Reservoir
-  Existing PRV

Pressure Zone

-  84 m Centre
-  96 m Centre Subzone
-  122 m Fern
-  138 m East
-  140 m Silver Valley West
-  158 m Albion
-  158 m Lower Grant
-  171 m 130 Ave
-  171 m Tretheway
-  176 m Silver Valley
-  224 m Grant Mountain
-  241 m NE
-  293 m Rothsay
-  329 m Garibaldi



Copyright Notice: These materials are copyright of Kerr Wood Leidal Associates Ltd. (KWL). District of Maple Ridge is permitted to reproduce the materials for archiving and for distribution to third parties only as required to conduct business specifically relating to the Drinking Water Master Plan Update. Any other use of these materials without the written permission of KWL is prohibited.

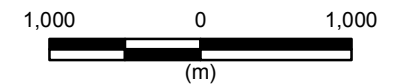

Project No. 173-164	Date June 2016
------------------------	-------------------

Existing Water System

Figure 2-1

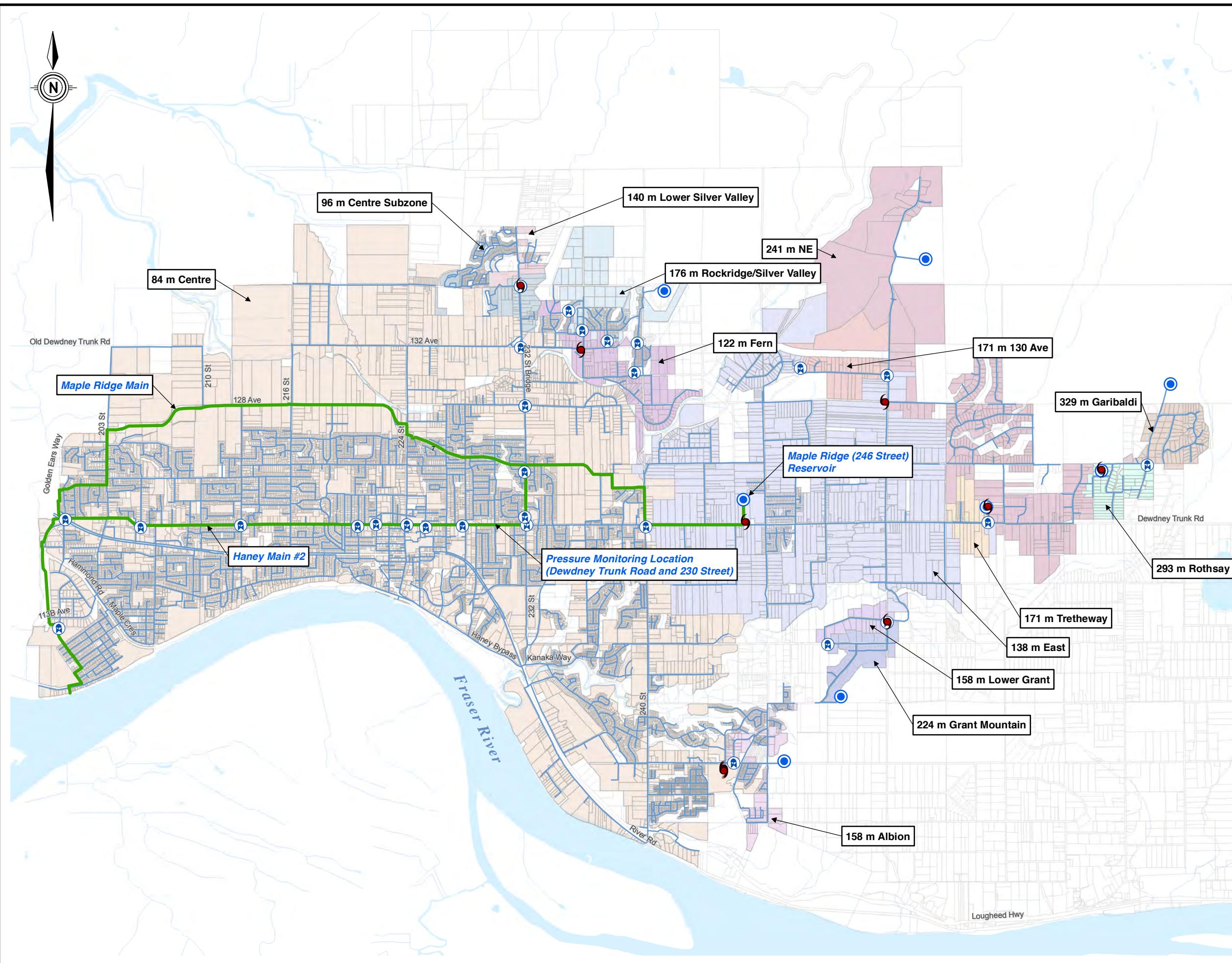

Path: O:\10100-0199173-164\430-GIS\MXD-Rp\173164_Figure2-1_ExistingWaterSystem.mxd Date Saved: 08/06/2016 9:34:44 AM
Author: RTaylor

O:\0100-0199\173-164\501-Drawings\173-164\Fig2-2_ExistingSystemSchematic_20160203.dwg July 28, 2015

ID	Connection Location	Large Valve		Small Valve	
		Dia. (mm)	HGL Setting (m)	Dia. (mm)	HGL Setting (m)
1	Kingston, south of 113B Ave	200	84.0		
2	DTR & Lougheed Why	250	72.0	100	80.00
3	DTR & 206 St	200	78.0		
4	DTR & Laity St	200	83.32	75	87.14
5	DTR & 221 St	200	80.26		
6	DTR & 222 St	300	84.90	200	88.42
7	DTR & 224 St	150	87.10		
8	DTR & Edge St	250	81.35	100	89.81
9	DTR & 228 St	200	81.92	150	88.96
10	DTR & 232 St	300	87.51	150	96.00
11	232 St & Cherrywood	150	90.10		
12	232 St & 124 Ave	150	84.62		
13	232 St & 128 Ave	200	73.86	50	77.38
14	DTR & 240 St	300	89.6		
15	232 St & 132 Ave	200	85.62		
16	241 St & 125 Ave			19	122
17	DTR & 263 Street	150	162.93	50	170.6
18	256 & 130 Avenue	150	153.25	50	170.8
20	McNutt Road & 12400	200	286.2	50	292.5
21	245B & 104 Avenue	150	112	50	--
23	237 A & 132 A Avenue	150	112	50	--
24	239B & 132 Avenue	150	120	50	--
25	239B & 140 Avenue	200	106.11	50	--
26	130A Avenue & 130 Connector	150	119.83		
29	Rothsay Street & 122nd Avenue	100	249.4		
30	1345B 235 Street	150	120	75	--
31	236 Street & Larch Avenue	200	120	75	--
32	252 Street & 112 Avenue	150	152	50	--
XX*	203 Street & Telep Avenue	300	78	--	--
XX*	232 Street Pump Station & PRV	200	140	75	142
XX*	224 Street & 127 Avenue	300	80	--	--

* XX denotes a PRV that has not yet been numbered in Maple Ridge's PRV table

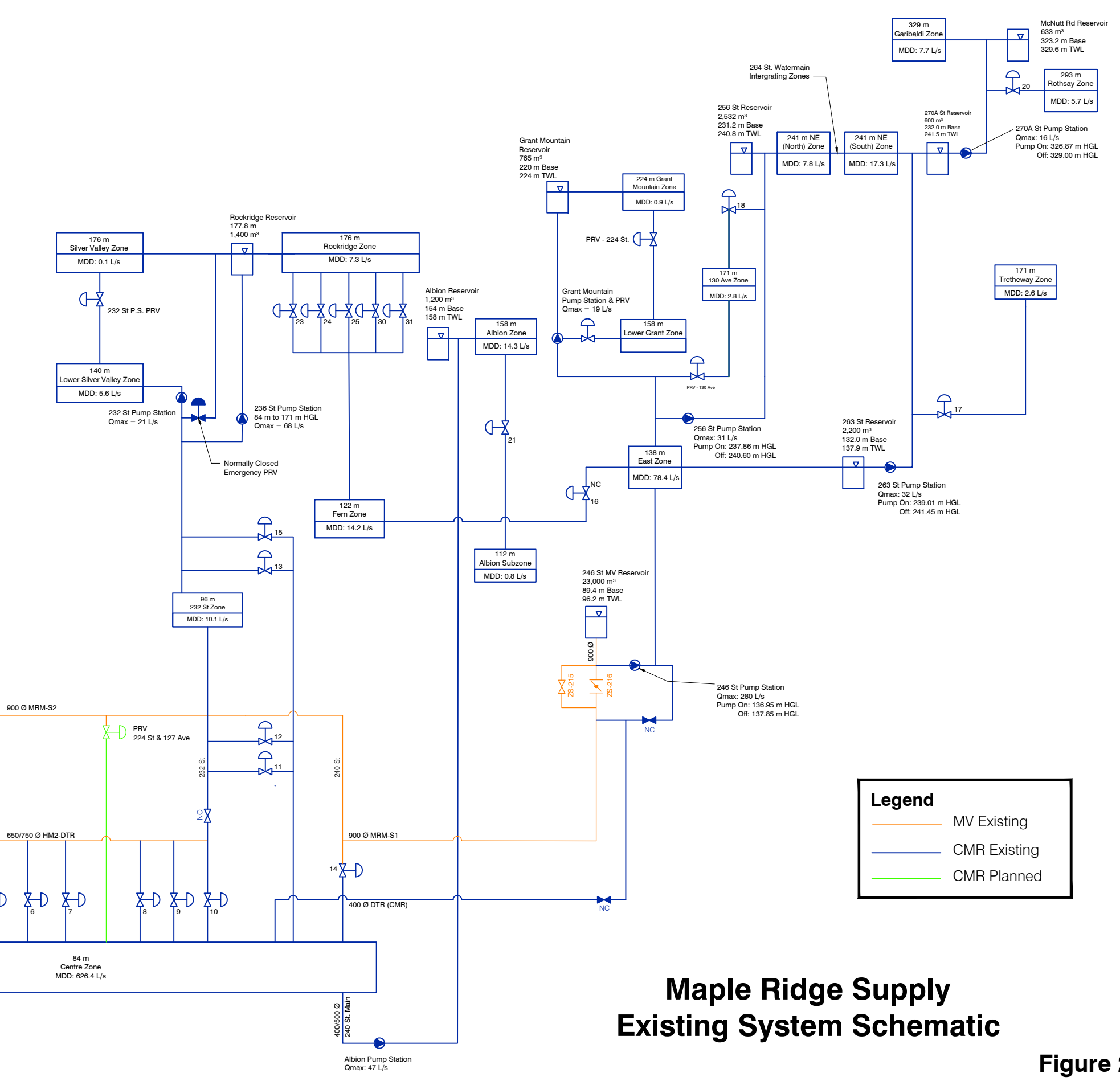

Legend





- MV Existing
- CMR Existing
- CMR Planned





Maple Ridge Supply Existing System Schematic

Figure 2-2

City of Maple Ridge Water Distribution Master Plan

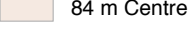
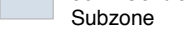
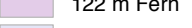
Legend

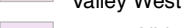
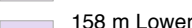
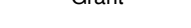
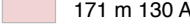
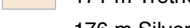
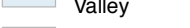
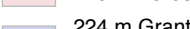
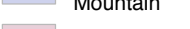
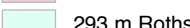
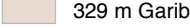
-  Water Main
-  Existing Booster Pump Station
-  Existing Reservoir
-  Existing PRV
-  Maximum Ground Elevation Location

Pressure Zone	
	84 m Centre
	96 m Centre Subzone
	122 m Fern
	138 m East
	140 m Silver Valley West
	158 m Albion
	158 m Lower Grant
	171 m 130 Ave
	171 m Tretheway
	176 m Silver Valley
	210 m Forest
	224 m Grant Mountain
	241 m NE
	293 m Rothsay
	329 m Garibaldi



Copyright Notice: These materials are copyright of Kerr Wood Leidal Associates Ltd. (KWL), City of Maple Ridge is permitted to reproduce the materials for archiving and for distribution to third parties only as required to conduct business specifically relating to the Drinking Water Master Plan Update. Any other use of these materials without the written permission of KWL is prohibited.

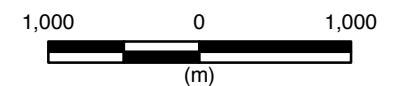

Project No. 173-164	Date June 2016
------------------------	-------------------

Maximum Ground Elevations By Pressure Zone

Figure 2-3

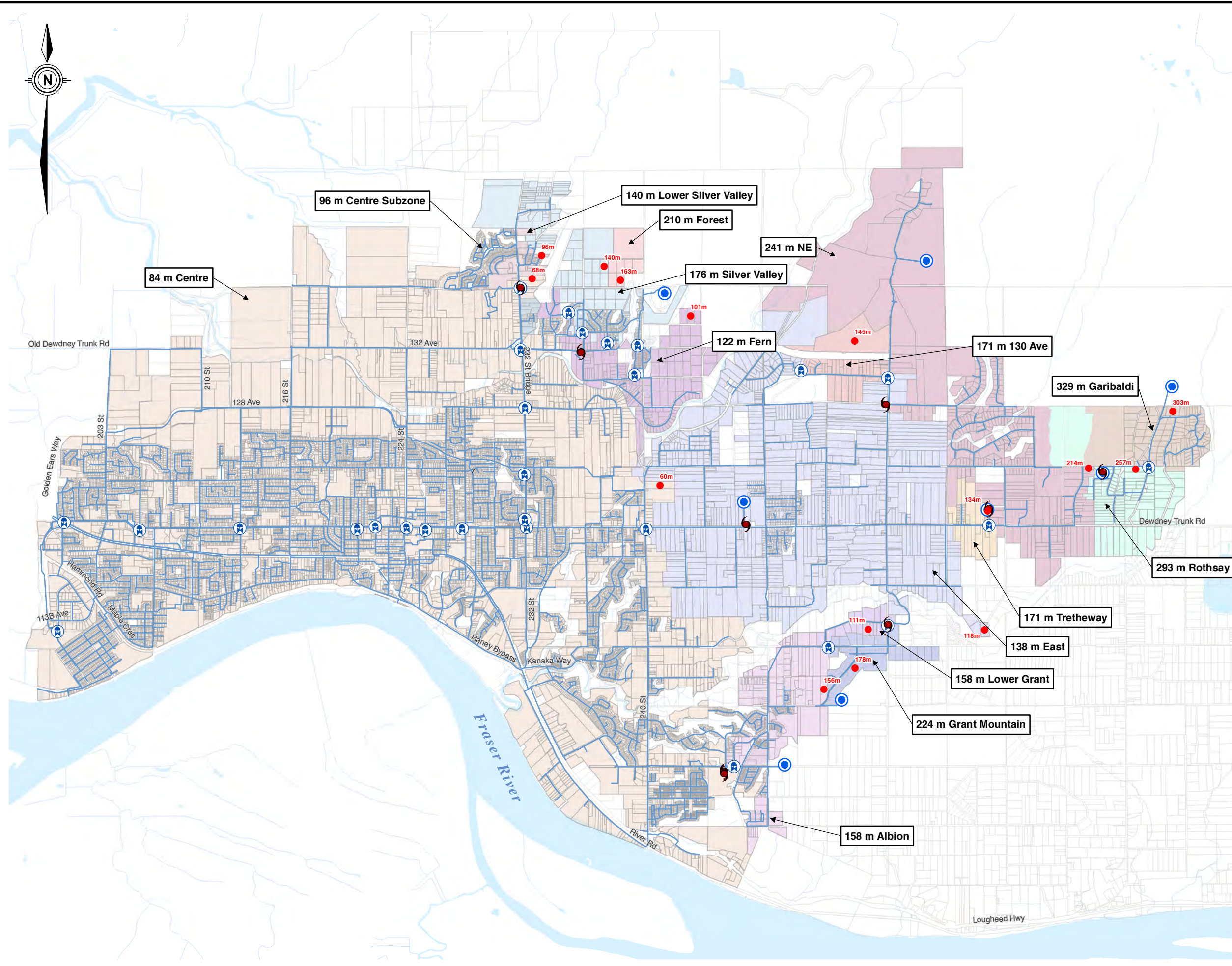

Path: C:\0100-0199\173-164\430-GIS\MXD-Rp173164_Figure2-3_MaximumGroundElevationByZone.mxd Date Saved: 17/06/2016 2:19:02 PM Author: FTaylor



3. Water Model Update

3.1 Summary of Model Build

The existing model was built by KWL in 2002 using WaterCAD software and has received numerous updates over the years to reflect system updates and expansions. Updates for the current master plan projects include:

- updated demands to reflect existing (design), existing (actual), 2018, 2023, and 2041 (future) time horizons;
- addition of the Metro Vancouver Maple Ridge Main, including PRV connections;
- addition of Extended Period Simulation (EPS) functionality and updated pump controls;
- addition of Water Quality Modelling (WQM) functionality including water age modelling and chlorine constituent modelling. See separate Water Quality Optimization memorandum for details;
- addition of future planning scenarios to reflect the upgraded water system based on the projects identified during the master planning process; and
- various minor updates/water main replacements.

3.2 Water Main Update

The existing water main network within WaterCAD was maintained from previous KWL/City work. Modeled pipes were updated based on record drawings provided to KWL by the City as required.

Figure 2-1 shows the existing pipe network included in the model. An inventory of the existing water main piping from the model is included in Appendix B. The inventory includes facilities, junctions, pipes, and pipe lengths by diameter.

3.3 Facility Update

Facility information was maintained in the existing model and updated as follows:

1. Updated the 246 Street Pump Station to reflect upgrades – removed the orifice plate and replaced the fixed speed pump with variable frequency drives (VFDs);
2. New settings for all PRV stations feeding the 84 m Centre Zone, based on field work conducted during the Summer of 2014;
3. Updated pump station control information for all pump stations based on reservoir level and/or pressure data; and
4. Added chlorine dosing information to various pump stations.



4. Residential Populations and Land Use

4.1 Data Sources

The following data sources were used in the development of residential populations:

1. AECOM: 2011, 2018, 2023 and 2041 Population Model; and
2. City of Maple Ridge: Official Community Plan Bylaw No. 7060-2014.

It should be noted that demands for institutional, commercial, and industrial (ICI) customers have been estimated on the basis of area using historical service meter data, and therefore population equivalents have not been estimated.

4.2 Residential Population Distribution Methodology

Residential Population Distribution for Majority of Service Area

The population distribution used for the majority of the service area was developed by AECOM for the Sanitary Master Plan and was provided to KWL by the City. The population distribution was reviewed and approved with the City's Planning Department prior to use. The distribution provided a lot-by-lot population for 2011 (Existing), 2018, 2023, and 2041.

In addition, the City identified areas where growth could possibly exceed the densities provided in the AECOM population model. For these areas, KWL estimated a further 'Possible OCP Densification' population scenario to ensure conservative results when sizing affected infrastructure.

Residential Population Distribution for 241 m, 293 m and 329 m Zones

AECOM did not develop population distributions for the 241 m Zone, 293 m Zone and 329 m Zone; therefore, populations were based on the number of future available lots (including infill and service area expansion) and an assumed population density of 2.9 capita per lot. It is noted that the majority of parcels within the 241 m, 293 m, and 329 m zones are outside of the Fraser Sewerage Area.

The estimated number of future lots was based on the current number of lots plus an estimate of the number of infill lots. The number of potential infill lots was calculated for the future OCP land use zone designation (Suburban Residential), based on the total net lot area divided by the minimum allowable lot size (0.4 ha/ lot). The assumptions used to calculate the net lot area are:

- stream buffers (15 m or 30 m depending on creek) are excluded from the net lot area;
- lot area with slopes greater than 25% are excluded from the net lot area; and
- a road allowance of 20% was subtracted from the net lot area for lots greater than 1.2 ha in size.



4.3 Future Land Use

The potable water service area is projected to densify and grow at the boundaries of the system to include currently un-serviced regions zoned ICI or suburban residential adjacent to existing serviced areas.

Several specific areas of expansion and densification include:

Thornhill Urban Reserve – Urban development in the Thornhill area will not occur until the City's population exceeds 100,000 and capacity in the urban area boundary is approaching build-out. Prior to urban development occurring, an area plan is to be developed that will specify land-use patterns, density, and servicing requirements. Though the future population density is unknown, Thornhill was assumed to have a population of 19,429, based on the City's outdated 1996 OCP (the current OCP does not specify a future population for Thornhill).

Albion Flats – Albion Flats is a region of potential densification in the south 84 m Centre zone. The City has requested that planning in the 240th Street corridor consider the possibility of Albion Flats being built out in the future (development south of 105 Avenue only).

Kwantlen First Nations (KFN) Reserve – In years past, KFN has expressed interest in receiving water supply from the City. At the time, KFN identified an anticipated 43 L/s MDD demand (assumed to be 20 L/s BD and 23 L/s SD) to be potentially connected to the Albion pressure zone. The timing of connection is uncertain, and there is no active application request.¹

Possible OCP Densification – The City has identified several parcels of land in the 84 m Centre Zone, 134 m East Zone, and 122 m Fern Zone that may develop to densities greater than described by the OCP. An additional scenario was assessed to examine the impact on system performance should the City approve certain pockets of densification in excess of the currently approved OCP.

The additional densification in these specific areas is not included in the base demand scenarios for the 2018, 2023, and 2041 time horizons, and is analyzed independently.

¹ KWL, *Technical Memorandum Re: Kwantlen First Nations Water Servicing*, July 2011, KWL file #173.142.



5. Existing Demands

5.1 Introduction

The existing water demands in the model were updated as part of this assignment. Two existing demand scenarios were developed: a year 2013 demand scenario and a 'design' demand scenario that is based on year 2013 base demands and year 2009 seasonal demands. The 'design' demand scenario is reflective of a year with a hotter summer (i.e., 2009), in which seasonal demands (mostly irrigation) are higher, resulting in a higher maximum day demand. Further, it should be noted that 2009 predates the adoption of more restrictive sprinkling regulations; thus, use of the 2009 peaking factor was thought to be conservative.

At the time of model demand development, 2015 seasonal demands were not yet available, and 2014 seasonal demands were less than in 2013. Subsequently, Metro Vancouver has reported that peak day flow in Maple Ridge in 2015 was 13% lower than in 2009. We therefore believe the 'design' demand scenario provides appropriate design flows.

5.2 Source Data

The following data sources were used in the demand build:

1. Metro Vancouver: Bulk Meter Data, 2009, 2013, and 2014;
2. The City: Service Meter Data, 2013;
3. The City: Water System Maps;
4. the City: Water System SCADA data, 2013; and
5. AECOM: 2011 ('Existing') Population Model with amendments as described in Section 4.2.

5.3 Data Quality Control

Data quality control procedures are outlined in the following sections.

Water Service Meter Records

KWL reviewed the water meter records provided by the City and found that 151 of the 1984 service meter records included duplicate or faulty GIS link data. KWL conducted a manual review of these meter records and with assistance from City staff, was able to link 1971 out of 1984 records. The remaining unlinked records constitute a negligible portion of the flow and were discarded from the analysis.

Pressure Zone Assignment

In order to improve lot-to-node demand assignment, each lot in Maple Ridge is assigned a pressure zone in GIS.



5.4 Existing Water Balance

Introduction

The existing demands have been broken into several components for the purpose of modelling. These demand components are discussed in detail in the following sections and are summarized in Figure 5-8, located at the end of this section.

Base Demand (2013)

Base demands are the water demands that do not vary seasonally. They are typically due to indoor water usage and industrial process usage.

Figure 5-6, located at the end of this section, shows the hourly and daily average demand for the entire City for the month of January 2013. The base demands have been calculated from flows measured by Metro Vancouver at the Lougheed and Powerline meter (the only source of water for the City) and reservoir levels in the 246 Street Reservoir. The base demand is equal to the flow through the Lougheed and Powerline meter plus or minus the flow of water out of or into all system reservoirs (net flow stored).

The calculated base demand for the system is 303 L/s. The demand was divided into the following categories, which are described in greater detail below.

- Non-revenue Water (NRW);
- Base Demand, ICI, Metered (BD-ICI-M);
- Base Demand, Residential, Metered (BD-RES-M);
- Base Demand, Multi-Family, Metered (BD-MF-M);
- Base Demand, ICI, Non-Metered (BD-ICI-NM); and
- Base Demand, Residential, Non-Metered (BD-RES-NM).

Nighttime Flow and Non-Revenue Water (NRW)

Nighttime flow can generally be separated into legitimate nighttime usage and non-revenue water (NRW). The largest component of NRW is generally leakage from the water system. Typical values for legitimate nighttime usage in systems the size and composition of the City are approximately 4 L/hr/service. For a total of approximately 18,700 services in the City, the estimated legitimate nighttime usage is therefore 20.8 L/s.

Citywide observed nighttime flows are as low as 63.5 L/s (January 20, 2013). This suggests that up to 42.7 L/s (63.5 L/s – 20.8 L/s) of nighttime flow falls into the category of NRW or 14% of the Base Demand. This value is compared with values for other utilities in the NRW Benchmarking section below.

Metered ICI Base Demand (BD-ICI-M)

All Institutional, Commercial and Industrial (ICI) parcels in the City have service meters. The ICI service meters are read on a quarterly basis and the total volume for the January to April 2013 metering period (winter/early spring) equates to an average flow rate of 47.1 L/s. The result is a calculated base demand unit rate of 0.084 L/s/ha, based on the gross ICI lot area of 563 ha. Based on a review of citywide demands, it was found that the winter/early spring metering period has little or no seasonal demand water use.



Metered Single and Two-Family Residential Base Demand (BD-RES-M)

Residential meters (single and two-family dwellings) were totalized for the January to April 2013 (winter/early spring) metering period. The estimated metered residential population is 3,671 and the average metered flow was 15.3 L/s; therefore, the metered single-family residential base demand rate is calculated to be 361 L/ca/day.

Metered Multi-Family Residential Base Demand (BD-MF-M)

Residential meters (multi-family dwellings) were totalized for the January to April 2013 (winter/early spring) metering period. The estimated metered multi-family residential population is 10,888 and the average metered flow was 26.8 L/s; therefore, the metered residential multi-family base demand rate is calculated to be 213 L/ca/day.

Non-Metered ICI Base Demand (BD-ICI-NM)

The calculated metered unit rate of 0.084 L/s/ha from the metered ICI properties was used to develop an estimate of the non-metered ICI demands on a per-hectare basis. Based on the non-metered ICI area of 69 ha, the calculated base demand is estimated as 5.8 L/s.

Non-Metered Residential Base Demand (BD-RES-NM)

The total BD for the previous categories is 160.7 L/s (42.7 L/s NRW + 52.9 L/s ICI + 65.1 L/s metered residential). Of the total observed BD of 303 L/s, the remaining flow of 142.3 L/s is attributed to non-metered residential properties.

Based on the total non-metered population of 47,380, the non-metered residential base demand was calculated to be 260 L/ca/day. Note that this unit rate is less than the metered single and two-family rate (BD-RES-M) presented above (361 L/ca/day). This result is contrary to expectations since metering has been shown to reduce water use. KWL attribute this result to the fact that the City targets large water users for residential water meters, so metered users tend to have a higher average unit rate than non-metered users.²

Seasonal Demand (2013)

Seasonal demand is the amount of seasonal flow that is required over-and-above base demands, typically due to irrigation. Seasonal demands are a function of the size of the areas being irrigated, and the moisture deficits in the soil. The moisture deficit is, in turn, dependant on the weather. Seasonal demands therefore vary day-by-day and year-by-year. On the south coast of British Columbia, 2009 was a particularly hot and dry year and regional seasonal demands were generally higher than usual.

For this project, two demand cases for existing scenarios were built. 'Existing' demands were developed using actual 2013 water demands in order to perform model validation and to provide an accurate representation of current demands. In addition, 'design' demands were developed using 2009 seasonal demand values; the derivation of these demands and the rationale for using 2009 as a design case is described in the following section. These 'design' demand unit rates were subsequently used for future planning horizon scenarios.

² Large water users generally include properties with in-ground pools or in-ground sprinkler systems, properties greater than 0.4 ha in area, and properties with large diameter service connections. Refer to Maple Ridge Water Service Bylaw 6002.



As mentioned above, development of model demands was done before 2015 data was available. Subsequent data from Metro Vancouver shows that 2009 peak day flow was 20% greater than flow in 2013, and 13% greater than flow in 2015. We therefore believe using 2009 seasonal demand provides an appropriately conservative model design flow.

Figure 5-7, located at the end of this section, shows the hourly and daily average demand for July to mid-August 2013, corrected for reservoir storage variations as provided by Metro Vancouver and City SCADA information.

Based on a review of the flow data, it was found that the day with the highest demand of the year is July 25 with an average flow rate of 646 L/s; this is the maximum day demand (MDD). Subtracting the base demand (BD) of 303 L/s as derived above, the calculated seasonal demand (SD) for the system is 343 L/s. As with the base demand, the seasonal demand has been divided into several components for modelling purposes as follows:

- Seasonal Demand, ICI, Metered (SD-ICI-M);
- Seasonal Demand, Residential, Metered (SD-RES-M);
- Seasonal Demand, Residential, Non-metered (SD-RES-NM);
- Seasonal Demand, ICI, Non-Metered (SD-ICI-NM);
- Seasonal Demand, Multi-Family, Metered (SD-MF-M); and
- Seasonal Demand, Multi-Family, Non-Metered (SD-MF-NM).

SD has been empirically linked to lot area because the largest component of SD is water used for irrigation and irrigation usage depends directly on the size of the area being irrigated. However, because large lots are typically not completely cultivated and irrigated, irrigable lot area has been estimated as 50% of lot area up to a maximum of 0.75 acres (0.3 ha) per lot. Residential multi-family irrigable area is estimated at 37.3% gross lot area with no area cap, based on a sample set of representative properties that were reviewed using orthographic photos. ICI lot area is estimated at 22.2% of gross lot area with no upper limit based on a sample set of representative properties that were reviewed using orthographic photos.

Many seasonal demand components have been calculated based on service meter data that are read on a quarterly basis as discussed above. In order to convert the June to September quarterly demand from service meters into a seasonal demand representing maximum day, a peaking factor was calculated based on citywide flow data. The peaking factor was calculated as the ratio of maximum day flow rates to average quarterly flow rates. Based on the city-wide data, the peak SD is 343 L/s and the quarterly average SD is 190 L/s, resulting in a peaking factor of 1.809 ($=343/190$).

Metered ICI Seasonal Demand (SD-ICI-M)

The metered ICI seasonal demand was calculated based on the June to September service meter reading and the peaking factor discussed above.³ The total calculated SD-ICI-M is 40.0 L/s. The total area for metered ICI properties is 563 ha. Limiting the irrigated areas to 22.2% gross lot area as discussed above gives a total irrigable area 125 ha for a metered ICI seasonal demand unit rate of 0.32 L/s/ha.

³ In cases where the quarterly seasonal flow was lower than the quarterly base flow, the seasonal flow component was taken to be zero.



Non-Metered ICI Seasonal Demand (SD-ICI-NM)

The calculated metered unit rate of 0.32 L/s/ha from the metered ICI properties was used to estimate non-metered ICI demands.

The total area of non-metered ICI properties is 69 ha. Limiting irrigation to 22.2% gross area gives a total irrigable area of 15 ha for a total calculated SD-ICI of 4.9 L/s.

Metered Residential Seasonal Demand (SD-RES-M)

Residential meters (single and two-family) were totalized for the June to September 2013 reading period and their seasonal demand component was peaked using the factor of 1.809 explained above for a total SD-RES-M of 46.0 L/s.⁴

The total area of metered residential single and two-family properties is 1,619 ha. Limiting irrigation to 50% of gross lot area to a maximum 0.3 ha per lot gives a total irrigable area of 144 ha for a calculated unit rate of 0.32 L/s/ha, which (reassuringly) is the same as the ICI unit rate.

Metered Multi-Family Seasonal Demand (SD-MF-M)

Residential multi-family meters were totalized for the June to September 2013 reading period and their seasonal demand component was peaked using the factor of 1.809 explained above for a total SD-RES-M of 10.5 L/s.⁴

The total area of metered residential multi-family properties is 88 ha. Limiting irrigation to 37.3% of lot area gives a total irrigable area of 33 ha for a calculated unit rate of 0.32 L/s/ha, which is the same as the ICI and residential (single and two-family) unit rates.

Non-Metered Residential Seasonal Demand (SD-RES-NM)

The total SD for the previous categories is 101.4 L/s. Of the total observed SD of 343 L/s, the remaining flow of 241.6 L/s is attributed to non-metered residences (SD-RES-NM and SD-MF-NM).

The total area of non-metered residential properties is 2,316 ha. Limiting irrigation to 50% of gross lot area to a maximum of 0.3 ha per lot gives a total irrigable area of 720 ha and a calculated unit rate of 0.34 L/s/ha.

The single-family component of this is 685 irrigable hectares for a total demand of 229.8 L/s.

Non-Metered Multi-Family Seasonal Demand (SD-MF-NM)

The Multi-Family component of non-metered residential demand (discussed above) is 35 irrigable hectares for a total demand of 11.9 L/s at the calculated unit rate (SD-RES-NM) of 0.34 L/s/ha.

⁴ 22 meters with readings suggesting flow rates higher than 1,000 L/ca/day were excluded from this total as over-reading errors.



Existing (Design) Seasonal Demand

At the initiation of this study, 2013 represented the latest available water system data, and corresponds to the field measurements used for model validation. However, the summer of 2013 was not a historically hot, dry year and seasonal demands therefore do not reflect design conditions.

KWL considered the following factors to establish design demand:

- Metro Vancouver Sprinkling Regulations (Updated in 1993 and again in 2011);
- annual temperature and demand trends since 1993; and
- ongoing changes to conservation bylaws and enforcement.

Based on the foregoing considerations, KWL selected 2009 as an appropriate design year. While it was not the highest demand period on record, it represents a year with a hot, dry summer in which sprinkling regulations were in effect. Given that more stringent sprinkling regulations were implemented in 2011, the unit rates developed from 2009 should be moderately conservative if used for design purposes for estimating existing and future demands.

Figure 5-9, located at the end of this section, shows the water balance including design seasonal demand conditions.

Base demand in the City for 2009 was the same as 2013 (303 L/s), but MDD was 802 L/s. The resulting seasonal demand is 499 L/s or 1.455 times the 2013 SD of 343 L/s. The 2013 and 2009 demand unit rates are shown in the following table.

Table 5-1: Design Demand Rates

Year	2013		2009	
	BD	SD	BD	SD
ICI-M	0.084 L/s/ha	0.32 L/s/ha	0.084 L/s/ha	0.47 L/s/ha
ICI-NM	0.084 L/s/ha	0.32 L/s/ha	0.084 L/s/ha	0.47 L/s/ha
RES-M	361 L/ca/day	0.32 L/s/ha	361 L/ca/day	0.47 L/s/ha
RES-NM	260 L/ca/day	0.34 L/s/ha	260 L/ca/day	0.49 L/s/ha

NRW Benchmarking

In order to benchmark the NRW value estimated above, the Infrastructure Leakage Index (ILI) was calculated for the system.⁵ The ILI is defined as the ratio of NRW to Unavoidable Annual Real Loss (UARL).

$$ILI = \frac{NRW}{UARL}$$

UARL is a statistically derived value that represents the minimum amount of leakage expected from an ideal water system, based on system pressure, length of water mains, and length of service connections. Since leakage on the 'customer' side of water service meters is technically metered flow, a modified version of the UARL formula was used to account for different service lengths for metered/ non-metered properties:

$$UARL \left(\frac{L}{day} \right) = P * (18 * L_m + 0.8 * (N_{c_m} + N_{c_{nm}}) + 25 * (L_{c_m} * N_{c_m} + L_{c_{nm}} * N_{c_{nm}}))$$

⁵ See AWWA M36 'Water Audits and Loss Control Programs, Third Edition'.



For Maple Ridge, the following assumptions were used, based on a desktop mapping exercise:

- $L_m = 418$ km, length of water mains in the DMR system;
- $LC_m = 5$ m, average length of service line upstream of water meter on metered properties;
- $NC_m = 2,143$, count of metered properties;
- $LC_{nm} = 17.5$ m, average length of service line to non-metered properties;
- $NC_{nm} = 16,563$, count of non-metered properties; and
- $P = 60$ psi, average system pressure.

The estimated UARL for the system is 20.9 L/s. Based on a NRW of 42.7 L/s (see section 3.3 above), the calculated ILI for the City is 2.05. Typical ILI values range from 2 to 6 with an average ILI of 4.38.⁶

This is a good score compared to comparable systems and suggests that the City is doing a good job of leakage management. This includes asset renewal (replacing CI and AC water mains), and pressure management.

Diurnal Patterns

Diurnal demand patterns for the model were developed for the 2011 Water Master Plan using winter and summer SCADA data provided by the City and MV.⁷ KWL reviewed the patterns developed in 2011 (using 2009 data) and updated them based on 2013 demand data. The updated diurnal patterns for each demand component are presented in the following sections.

BD-RES

A base day residential pattern was developed using January 2013 demand data from a primarily residential zone (Silver Valley Area). The 2013 diurnal pattern is largely the same as the 2011 pattern but the highest water use has been adjusted to occur an hour earlier in the day (18:00).

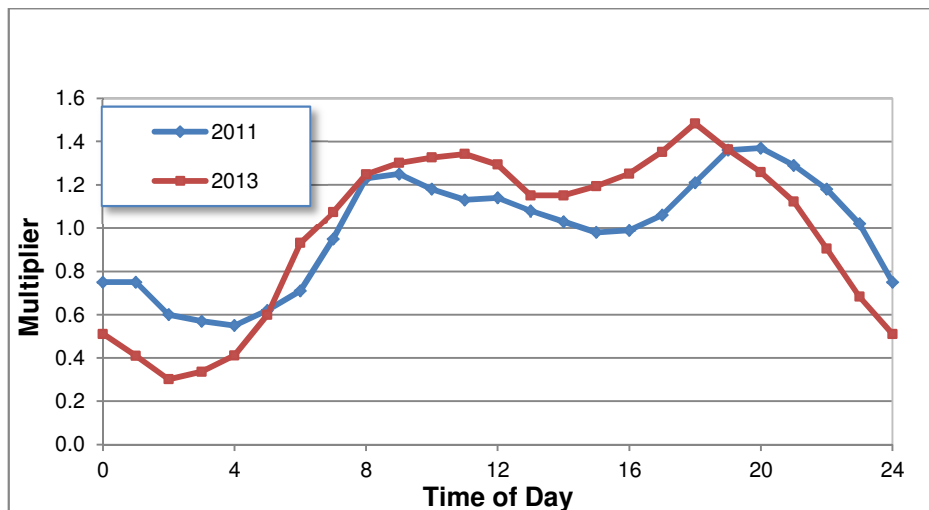

Figure 5-1: BD-Res Diurnal Pattern

⁶ AWWA M36 'Water Audits and Loss Control Programs, Third Edition'.

⁷ KWL, *Water Distribution Master Plan*, March 2011, KWL file #173.136.



BD-ICI

The BD-ICI pattern was developed by subtracting the proposed residential diurnal pattern, weighted by total demand, from a mixed-use zone using January 2013 data. The 2013 diurnal pattern is largely the same as the 2011 pattern but has higher water use during daytime hours and lower water use during the night.

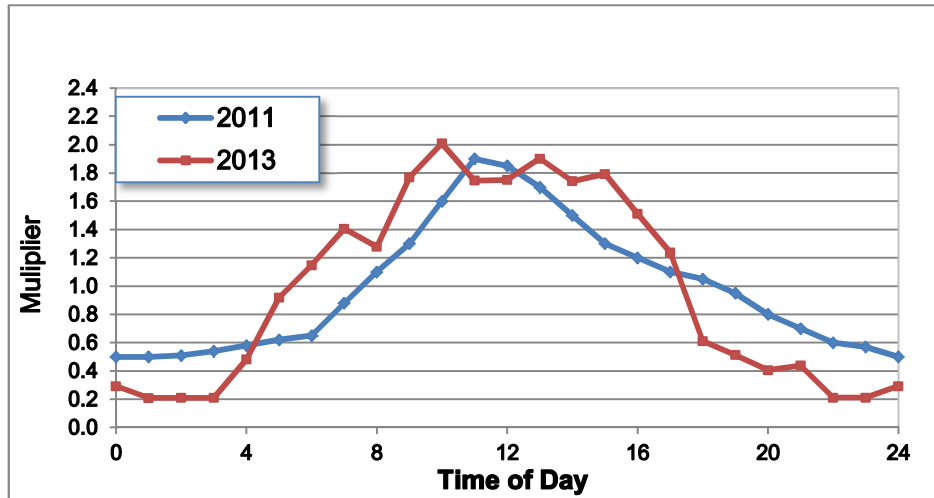

Figure 5-2: BD-ICI Diurnal Pattern

SD-RES

An SD pattern was developed using MDD diurnal patterns in primarily residential zones and subtracting the BD pattern established above. The 2013 diurnal pattern has a lower peak earlier in the day (peaking factor of 2 at 20:00 versus a peaking factor or 2.5 at 21:00). This relatively significant change in diurnal patterns is attributed to changes in sprinkling restrictions that came into effect in 2011.

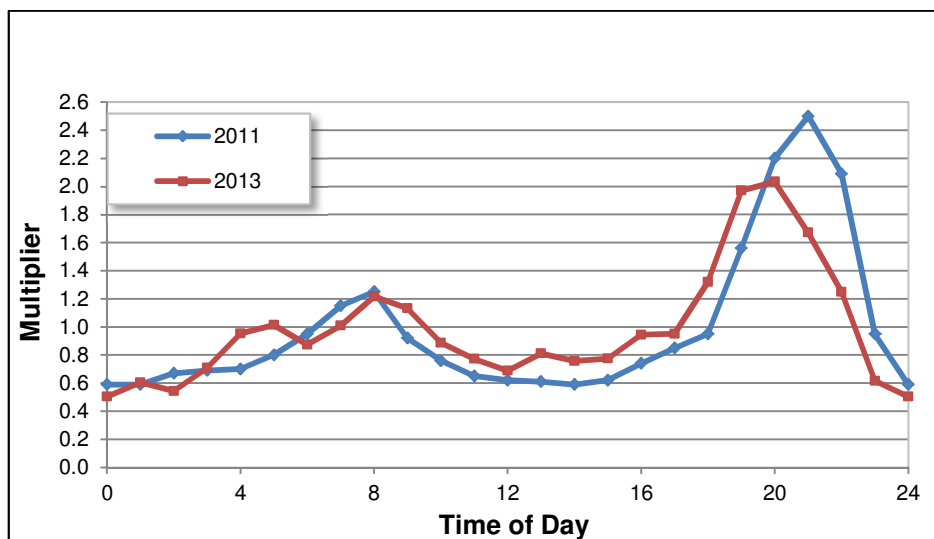

Figure 5-3: SD-RES Diurnal Pattern



SD-ICI

A significant shift in SD-ICI water use has been observed since the previous model update. The new pattern shown below was estimated based on the 2011 sprinkling regulations, which allows watering on ICI properties between 1:00 a.m. and 6:00 a.m. Monday to Thursday, and 4:00 a.m. to 9:00 a.m. on Friday. KWL has observed similar patterns in adjacent cities such as the City of Surrey since the updated regulations have been implemented. The demands developed using this pattern also empirically match the remaining demand after the previous patterns have been removed from the total observed hourly demand.

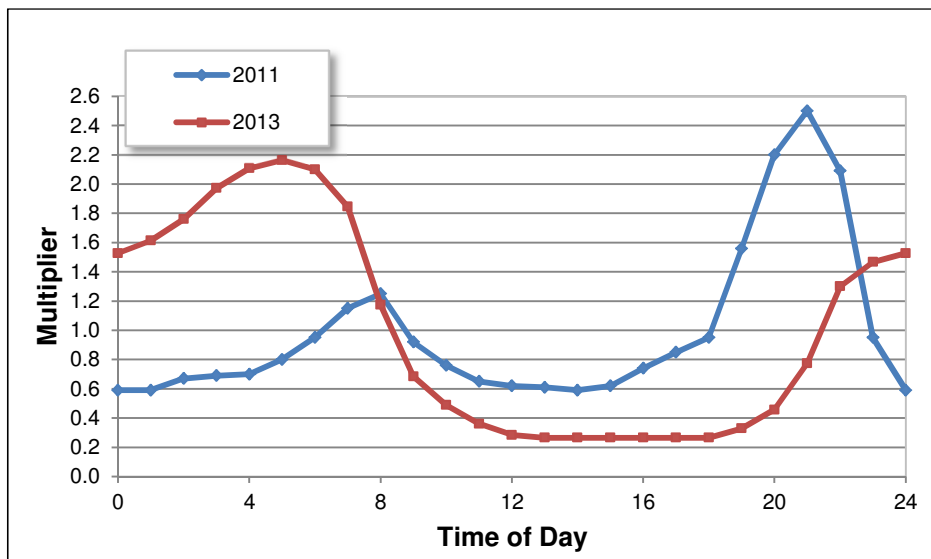

Figure 5-4: SD-ICI Diurnal Pattern

NRW

The non-revenue water losses are modelled as a constant demand throughout the day (i.e., a flat diurnal pattern equal to 1).

Combined Diurnal Patterns

Figure 5-5 shows a plot of the demand constituents used in the model and a comparison of the total demands from the model (using the demand patterns developed above) and the total demands measured by SCADA.

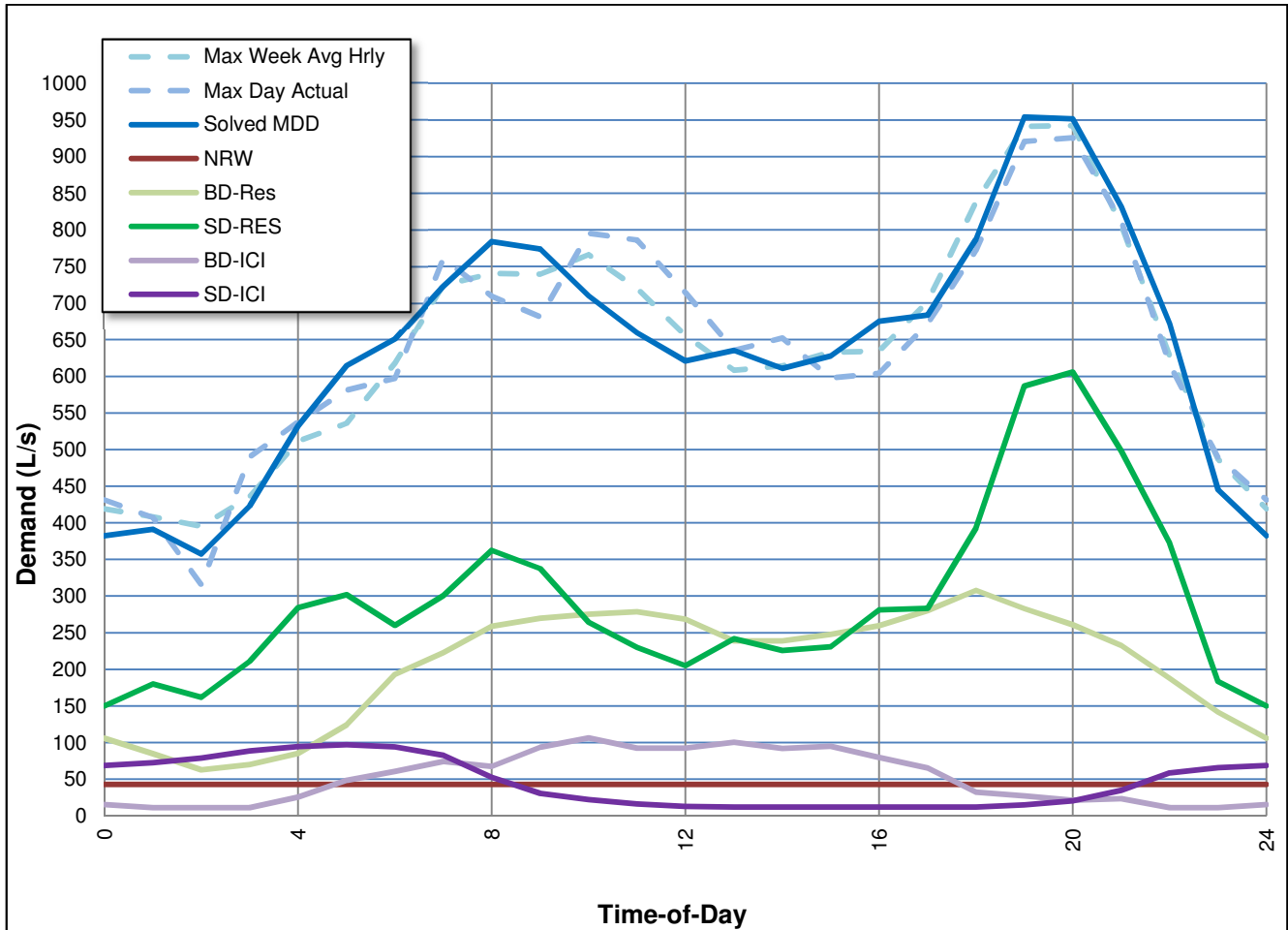

Figure 5-5: Comparison Between Modelled and SCADA Demands

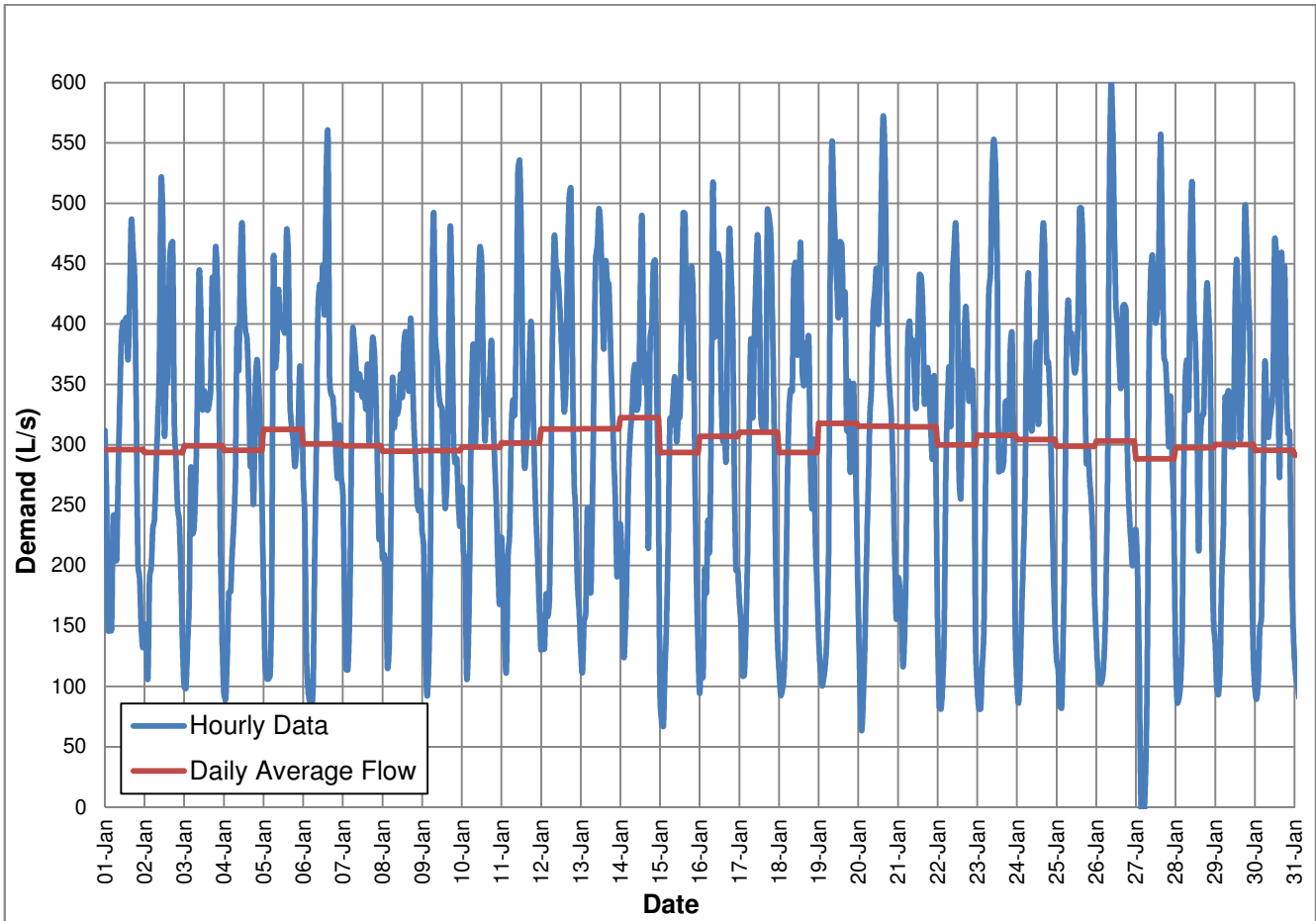

Figure 5-6: Base Demands

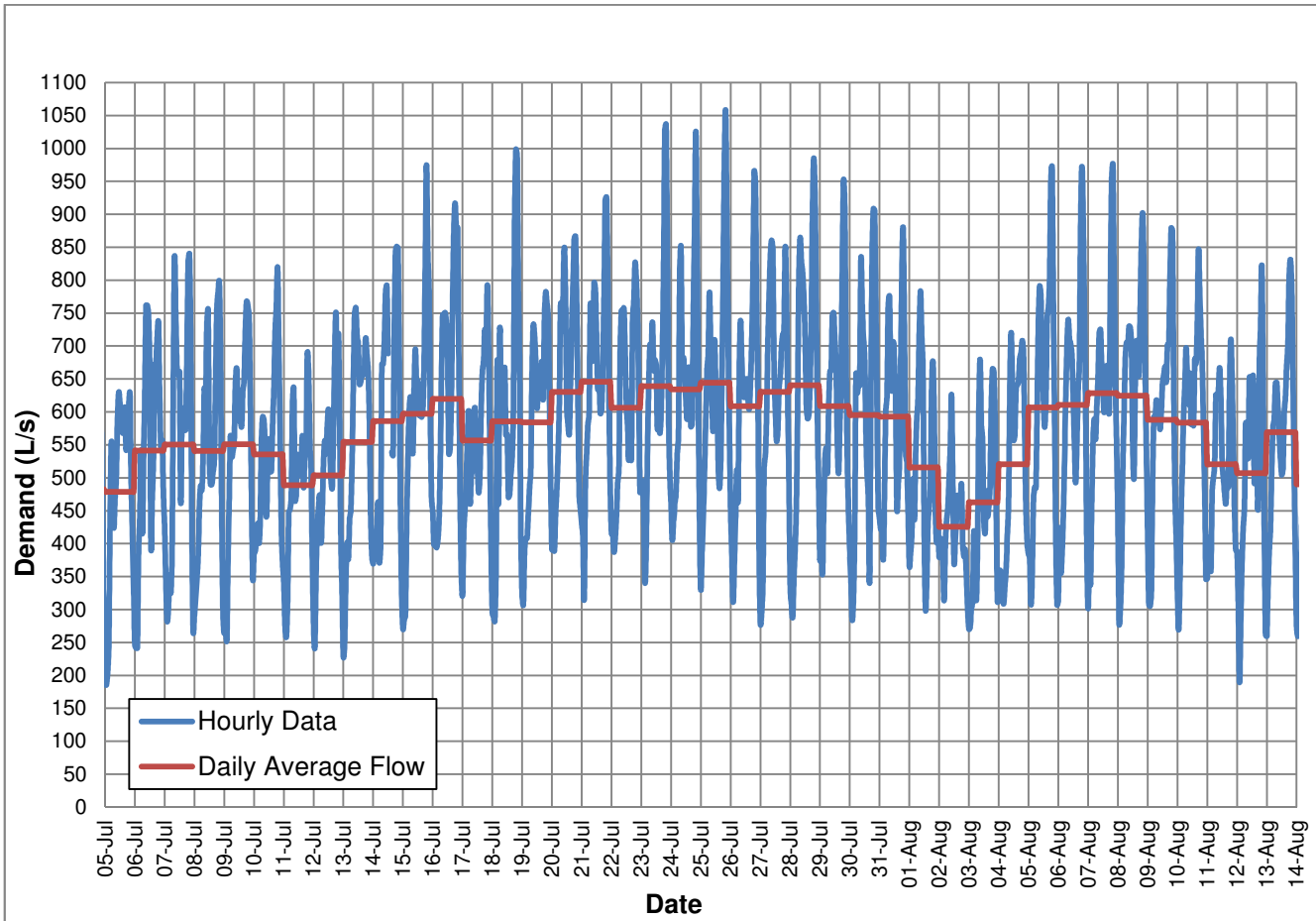

Figure 5-7: Seasonal Demands

(2013 Flow Meter Data; 2011 Census Data)

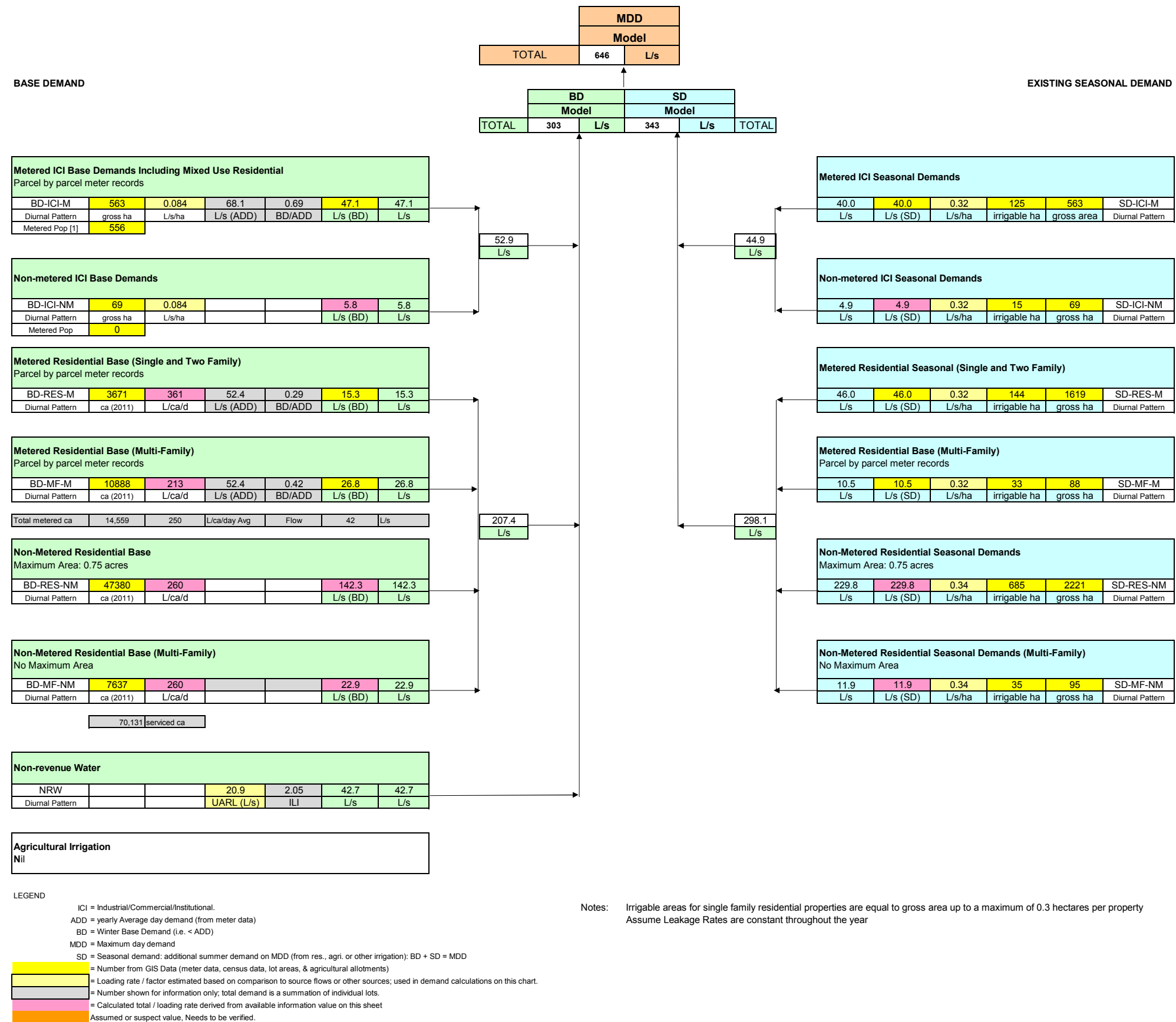
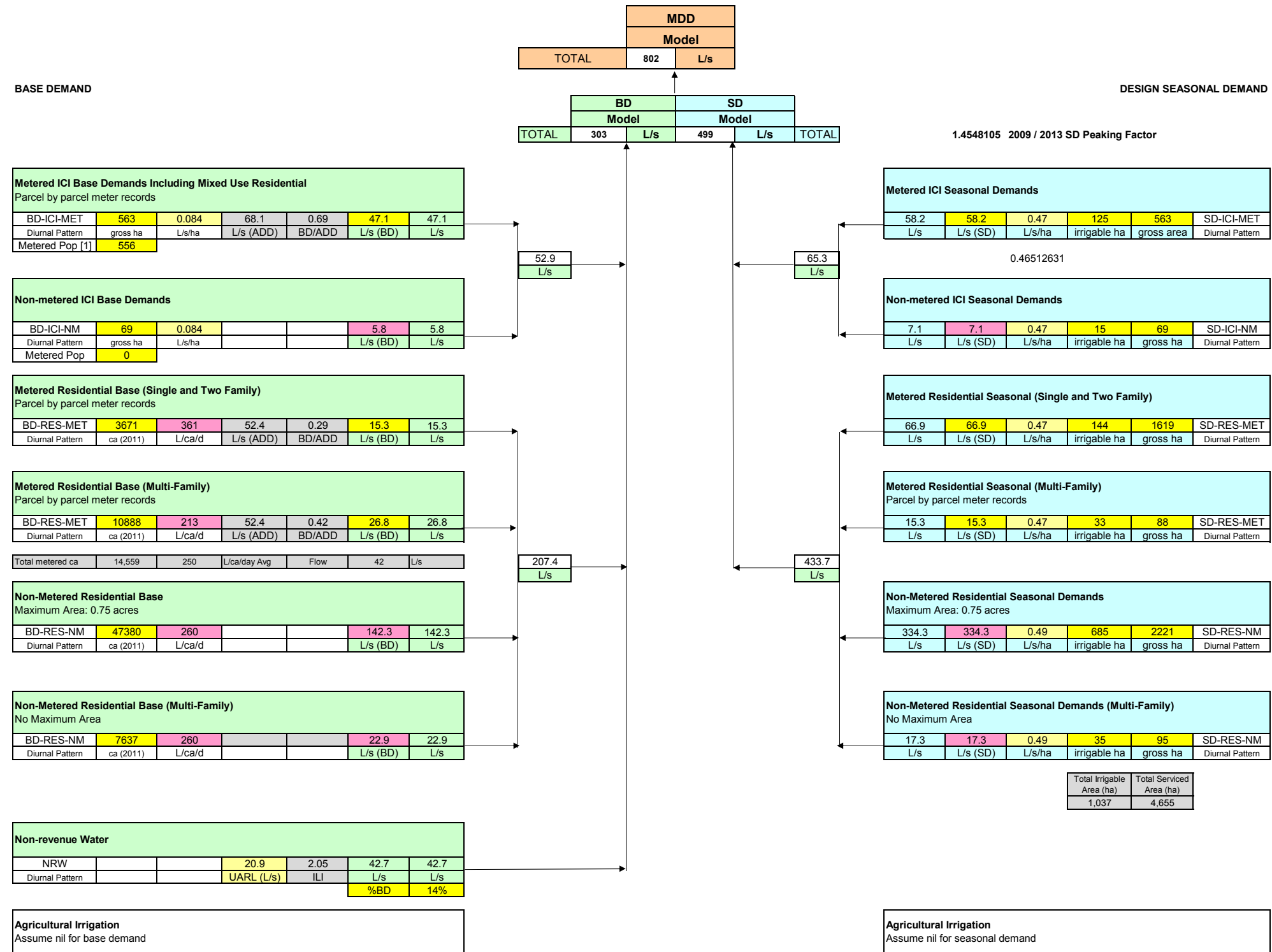

Figure 5-8: City of Maple Ridge Water Model Demand Summary - Existing (2013)

(2009 Flow Meter Data; 2011 Census Data)



LEGEND

- ICI = Industrial/Commercial/Institutional.
- ADD = yearly Average day demand (from meter data)
- BD = Winter Base Demand (i.e. < ADD)
- MDD = Maximum day demand
- SD = Seasonal demand: additional summer demand on MDD (from res., agri. or other irrigation); BD + SD = MDD
- [Yellow box] = Number from GIS Data (meter data, census data, lot areas, & agricultural allotments)
- [Light Green box] = Loading rate / factor estimated based on comparison to source flows or other sources; used in demand calculations on this chart.
- [Light Blue box] = Number shown for information only; total demand is a summation of individual lots.
- [Pink box] = Calculated total / loading rate derived from available information value on this sheet

Notes: Irrigable areas for single family residential properties are equal to gross area up to a maximum of 0.3 hectares per property
Assume Leakage Rates are constant throughout the year

Figure 5-9: City of Maple Ridge Water Model Demand Summary - Design (2009)



6. Future Demands

Future demands were developed for the years 2018, 2023 and 2041. The 2041 demands are based on the populations and land use described in Section 4. Residential demands were based on the AECOM population model including interim 2018/2023 time steps. It is noted that residential demand growth is not linear (e.g., the Town Centre area is conservatively anticipated to be built-out by 2023).

The timeline for non-residential development (amount and location) is unknown at this time; therefore, non-residential demands for 2018 and 2023 have been linearly interpolated between existing demands and 2041 demands. Parcels that change from residential to non-residential in the OCP have been included in the linear interpretation.

Alternate 2041 demand scenarios were also developed for the 'Thornhill Urban Reserve', 'Albion Flats', 'Kwantlen First Nations Reserve', and 'Possible OCP Densification' scenarios described in Section 0.

Future demands, demand components and demand unit rates are summarized in the following sections. The demands for the year 2041 for each scenario are also summarized in Figure 6-1.⁸

6.1 Base Demand

Future demand was distributed into the following categories, which are described in greater detail below.

- Non-revenue Water (NRW);
- Base Demand, ICI, Large Users (BD-Ind., BD-Com., BD-Inst.);
- Base Demand, ICI, Average Users (BD-Ind., BD-Com., BD-Inst.); and
- Base Demand, Residential, (BD-RES).

Future Residential Base Demand (BD RES)

A future residential base demand unit rate of 250 L/ca/day has been assumed for metered and non-metered parcels. The rate was calculated by taking an average of existing metered residential base demand rates. The total residential base demand is calculated by multiplying the unit rate by the future population. The results for each time horizon and the alternate planned scenarios are summarized in Table 6-1 below.

Table 6-1: Future BD-Res

	Population ⁹	L/ca/day	BD-Res (L/s)
2018	98,025	250	283.6
2023	114,836	250	332.3
2041	144,987	250	400.6
Thornhill	19,429	250	56.2
Kwantlen FN	N/A	N/A	20
Albion Flats	N/A	N/A	18
Possible OCP	6,550	250	19

⁸ Interim scenarios for 2018 and 2023 are based on interpolation between existing and 2041 conditions and are not summarized in a water balance figure.



Future Institutional, Commercial and Industrial Demand

As with existing ICI demands, future ICI demands have been calculated based on parcel area. However, within the metered users, there are a group of customers whose consumption is much higher than the average. These customers tend to be larger industrial operations and golf courses and it can be expected that their higher than average water demands will persist into the future. In order to accurately model this, existing ICI customers in the top fifth percentile (92 of 1,830 ICI meters) were isolated as 'Large Water Users' and their unit rates were calculated separately from all of the other customers and carried forward into the future scenarios. Demands and unit rates for the top fifth percentile large users are summarized in Table 6-2 below. Note that the average 2013 metered base demand ICI unit rate (BD-ICI-M) is 0.084 L/s/ha.

Table 6-2: Future BD-ICI – Top Fifth Percentile Large Users

	Type	Gross Area (ha)	L/s/ha	BD-ICI (L/s)
All Time Horizons	BD Industrial	28.2	0.2685	7.6
	BD Commercial	93.2	0.2574	24.0
	BD Institutional	136.0	0.0433	5.9

All other ICI users have been given a calculated rate based on existing average ICI area-based demand rates for each ICI type (industrial, commercial, and institutional). Future ICI base demands for these customers are summarized in Table 6-3 below.

Table 6-3: Future BD-ICI – Average Users

	Type	Gross Area (ha)	L/s/ha	BD-ICI (L/s)
2018	BD Industrial	67.5	0.0965	6.5
	BD Commercial	76.4	0.1131	8.6
	BD Institutional	181	0.0345	6.2
2023	BD Industrial	86.1	0.0965	8.3
	BD Commercial	97.5	0.1131	11.0
	BD Institutional	231	0.0345	8.0
2041	BD Industrial	153	0.0965	14.8
	BD Commercial	173	0.1131	19.6
	BD Institutional	410	0.0345	14.2

Non-Revenue Water (NRW)

The future NRW has been estimated based on the assumption that the existing ILI rate of 2.05 will be maintained moving forward. Since detailed plans of all future growth areas are not available (i.e., road alignments, individual development service sizes, etc.) we cannot accurately determine the future total length of the water mains and number of service connections but have instead estimated the total NRW growth based on total serviced area. The following assumptions for system growth are used:

1. Total length of pipe is approximately proportional to total serviced area;
2. Total serviced area in 2009 is 4,655 ha and for 2041 is 6,281 ha; and
3. Existing (design) UARL is 20.9 L/s.

Using these proportions, the UARL for 2041 is estimated as 28.2 L/s. At an ILI of 2.05, the calculated NRW is estimated as 57.8 L/s. Interim time horizons have been interpolated based on existing and 2041 NRW. Future NRW estimates are summarized in Table 6-4 below.



Table 6-4: Future NRW

	UARL (L/s)	ILI	NRW (L/s)
2018	22.2	2.05	45.5
2023	23.5	2.05	48.2
2041	28.2	2.05	57.8

6.2 Seasonal Demand

Future seasonal demand was distributed into the following categories, which are described in greater detail below.

- Seasonal Demand, ICI, Large Users (SD-Indust., SD-Com., SD-Inst.);
- Seasonal Demand, ICI, Average Users (SD-Indust., SD-Com., SD-Inst.); and
- Seasonal Demand, Residential, (SD-RES).

Future Residential Seasonal Demand

The existing design unit rate (based on 2009 seasonal demands) for metered residential water users is 0.47 L/s/ha.¹⁰ The total residential seasonal demand for each future time horizon was calculated by applying this rate to each of the projected residential service areas; the resulting demands are summarized in Table 6-5 below.

Table 6-5: Future SD-Res

	Irrigable Area (ha)	L/s/ha	SD-Res (L/s)
2018	1,010	0.47	470.0
2023	1,061	0.47	493.4
2041	1,242	0.47	577.9
Thornhill	160	0.47	74.4
Kwantlen FN	n/a	n/a	20
Albion Flats	n/a	n/a	18
Possible OCP	24	0.47	11.3

Future ICI Seasonal Demand

As with future base demands, existing ICI customers in the top fifth percentile were isolated as ‘Large Water Users’ and their seasonal demand unit rates were calculated separately from all of the other customers. Demands and unit rates for the top fifth percentile large users are summarized below in Table 6-6.

Table 6-6: Future SD-ICI – Top Fifth Percentile Large Users

	Type	Irrigable Area (ha)	L/s/ha	SD-ICI (L/s)
All Time Steps	SD Industrial	6.3	0.66	4.2
	SD Commercial	20.7	0.66	13.7
	SD Institutional	30.2	0.66	20.0

¹⁰ Note that the metered unit rate was selected over the average non-metered rate of 0.49 L/s/ha. Most future development and re-development is medium to high density, which is typically metered. Also, conservation measures should continue to hold constant or reduce unit rates over time.



All other ICI users have been given a calculated rate based on average ICI area-based demand rates and the existing SD-ICI unit rate of 0.47 L/s/ha. Seasonal demands for these users are summarized in Table 6-7 below.

Table 6-7: Future SD-ICI – Average Users

	Type	Irrigable Area (ha)	L/s/ha	SD-ICI (L/s)
2018	BD Industrial	21.9	0.47	10.2
	BD Commercial	37.3	0.47	17.3
	BD Institutional	46.7	0.47	21.7
2023	BD Industrial	24.5	0.47	11.4
	BD Commercial	37.5	0.47	17.4
	BD Institutional	56.3	0.47	26.2
2041	BD Industrial	34.0	0.47	15.8
	BD Commercial	38.5	0.47	17.9
	BD Institutional	91.1	0.47	42.4

6.3 Water Conservation

Consideration of potential water conservation measures and their effects on future demands is not included in the scope of work of this master plan update. As a result, no adjustments to future demand unit rates (base or seasonal) have been made to account for potential future water conservation initiatives. This assumption is conservative because base residential per capita demands are expected to decline relative to the current average, due to the ongoing adoption of water efficient appliances and fixtures.

6.4 Diurnal Patterns

Diurnal patterns for all future demands are assumed to be the same as the 2013 diurnal patterns derived in Section 5.4.

6.5 Summary of Future Demands

The future demands presented above are a best estimate based on existing water usage and the predicted growth and changes in land use. The demands as presented contain no factor of safety to account for increases in water use habits, unforeseen increases in density of development or climate change. However, the future demands contain sources of conservatism that are considered to make inclusion of a factor of safety unnecessary as follows:

- Per capita water use in the City has been generally dropping but it has been assumed in the development of future demands that per capita water use will remain constant; and
- Future seasonal demands are estimated based on unit rates observed in 2009 that represents a year with a hot, dry summer in which sprinkling regulations were in effect. Given that more stringent sprinkling regulations were implemented in 2011, the unit rates developed from 2009 are considered to be moderately conservative when used for estimating future demands.



Existing actual and design maximum day demands and future maximum day demands for the years 2018, 2023 and 2041 by pressure zone are summarized in Table 6-8 below.

Table 6-8: Comparison of Existing and Future MDD by Zone

Zone	Existing (Actual) MDD (L/s)	Existing (Design) MDD (L/s)	2018 Future MDD (L/s)	2023 Future MDD (L/s)	2041 Future MDD (L/s)
122 m Fern	10.8	14.2	17.0	18.9	25.8
138 m East	58.9	78.4	76.3	78.8	88.8
140 m Silver Valley West	4.7	5.6	8.4	9.2	12.5
158 m Albion	12.3	14.3	24.7	30.1	42.6
171 m 130 Avenue	2.1	2.8	2.8	2.9	3.4
171 m Tretheway	2.0	2.6	2.5	2.5	2.5
176 m Silver Valley	-	7.4	16.6	21.4	39.6
210 m Forest	-	0.0	2.1	3.9	10.6
224 m Grant Mountain	0.7	0.9	4.6	6.4	13.2
241 m NE	19.5	25.1	48.8	60.6	103.5
293 m Rothsay	4.1	5.7	8.9	10.6	16.9
329 m Garibaldi	5.3	7.7	12.0	14.9	25.3
84 m Centre	511.3	626.4	689.5	739.3	818.6
96 m 232 HP Centre Subzone	8.1	10.1	11.6	12.0	13.8
Total	639.7	801.2	925.8	1011.6	1217.0

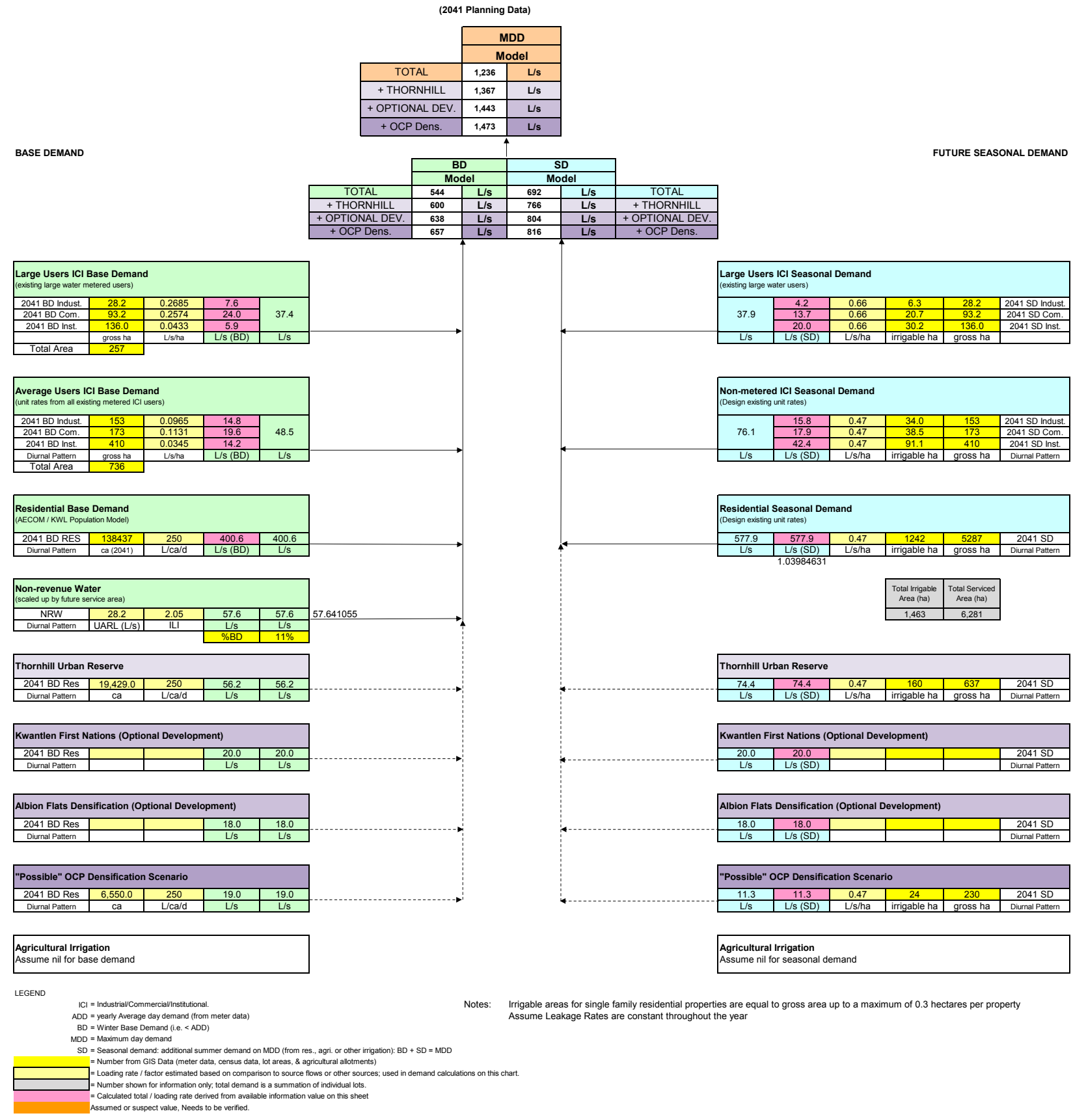

Figure 6-1: City of Maple Ridge Water Model Demand Summary - Future (2041)



7. Pressure Validation

7.1 Introduction

The updated water model was validated with pressure data collected by the City and KWL in 2014 and 2015. The pressure validation was conducted in several phases:

1. Initial validation attempt which revealed substantial discrepancies in measured and modelled pressures, particularly in the 240th Street Corridor;
2. Subsequent 240th Street Corridor data collection and local model calibration; and
3. Second validation attempt with calibrated friction factor in 240th Street water main.

The pressure validation methodology and results are discussed in the following sections.

7.2 240 Street Corridor Validation/Calibration

In February 2015, KWL and the City conducted flow tests due to the discrepancy between measured and modelled pressures and headlosses in the 240th Street corridor of the 84 m Centre Zone. Four hydraulic flow tests were performed as follows:

1. Hydrant flow test near Albion Pump Station;
2. Pump Station and Hydrant flow test (two tests with pump activation in stages);
3. Pump Station flow test (McClure Drive Supply only); and
4. Pump Station flow test (104th Avenue Supply only).

The following summarizes the results for each flow test. For additional details see KWL's email to the City dated March 10, 2015 with the subject: 240th Street Flow Testing Results- KWL File #0173.164 in Appendix C.

Flow Test 1

Acceptable agreement between model and field data except at Albion Pump Station. Measured pressure inaccuracy at Albion PS is suspected. No action required for the model.

Flow Test 2a and Flow Test 2b

Comparison of measured and modeled results indicates that an increase in headloss along 240th Street in model is required. As with Flow Test 1, the data in the Albion PS is questionable and should be further investigated due to the pressure inaccuracies. Increased headloss along 240th Street is required for the model to achieve agreement between field data and model results.

Flow Test 3

Modelled headlosses are shown to be slightly lower than field results. As for Flow Test 2a and 2b, a small increase in headloss along 240th Street is required in the model.

Flow Test 4

Field measured headlosses are inconsistent with the model along 104th Avenue and the discrepancy cannot be readily explained by pipe friction difference. It was suspected that there may be a localized flow restriction in this area, possibly due to a closed valve or pipe blockage. A closed valve was subsequently discovered in this area based on additional flow testing.



Results

Based on the results found during the flow tests and some trial and error adjustments to the model, it was found that decreasing the Hazen Williams C along 240th Street from 130 to 110 resulted in a better fit for headloss overall.

7.3 Pressure Validation (Attempt No. 2)

Validation Scenarios

Pressures were validated for peak hour demands and base demands as follows:

- Peak Hour Pressure Validation – July 21, 2013, 8 - 9 p.m.: Using an Extended Period Simulation (EPS) model of Maximum Day Demand, determine the system pressure during peak hour demands (8:00 p.m. to 9:00 p.m.); and
- Base Demand Pressure Validation – January 9, 2013, 3:00 a.m. to 4:00 a.m.: Using an EPS model of Base Demand, determine the system pressure during winter nighttime demands (2:00 a.m. to 3:00 a.m.).

During the model validation, KWL considers a pressure difference between measured and modeled pressures of less than 10% to be acceptable.

Pressure Data

The model was run for the existing peak hour and base demand scenarios and pressure results were compared to SCADA data. Pressure monitoring locations are shown on Figure 7-1; the majority of the pressure validation locations are in the 84 m Centre Zone, while there is one in the 138 m East Zone, one in the 96 m Centre Sub-zone, and one at the Albion Pump Station discharge. Modelled and measured pressures are provided in Table 7-1 and Table 7-2 for peak hour and winter nighttime conditions respectively.

Data from the following pressure monitoring station was not used:

- Site 3 was reporting 0 psi; a sensor error or communications error is suspected; and
- Site 4 was found to be reporting higher-than-actual pressures, which was confirmed by the 240th Street corridor field program; therefore, the data was not used.

Discussion of Results

Peak Hour and Maximum Day Night-Time Pressures

Peak hour pressure validation results are provided in Table 7-1. This table summarizes measured and modeled pressures and HGLs for peak hour itself and at nighttime on maximum day. Measured and modeled pressure time-series are provided in Figures D-1 through D-14 in Appendix D.

The 84 m Centre Zone results (Sites 1, 2, 5-8, 10, 11, 12) show a consistent offset in the night-time HGL (field data higher than model data), but the offset generally reduces during the mid-day when demands are higher. This discrepancy suggests a connection between Haney Main #2 and the 84 m Centre Zone that has an anomalously high-pressure set point or no pressure regulation.



As seen in Figure D-1, the daytime fluctuations in field pressure show good agreement to modelled EPS pressures in timing and magnitude. This suggests that:

- the demands and diurnal patterns are accurate; and
- relative headlosses (change in pressure as a function of flow rate) are well represented by the model.

When examining the pressures in the 84 m Centre Zone at peak hour demand only (Table 7-1), one can see that measured and modelled values are generally within 10%, with the exception of Sites 11 and 12. Site 2 is also close to the 10% discrepancy threshold at 8.5%. Given that the discrepancy is highest at these locations and the mid-day reduction in discrepancy is the lowest at these sites, our best estimate is that the unregulated or anomalous pressure connection is somewhere between these three locations.

The pressure discrepancies in the 138 m East Zone (Site 9), the 96 m Centre Sub-zone (Site 13), and at the Albion Pump Station discharge are within the acceptable range.

Base Demand Pressures

Base demand pressure validation results are provided in Table 7-2. This table provides results at nighttime during winter when demands are lowest. The model consistently reports pressures approximately 10 psi lower than field results in the 84 m Centre zone, consistent with the theory of an unregulated connection. The measured and modelled values are within 10%, with the exception of Site 12. This site is located in the 84 m pressure zone, close to the potentially unregulated pressure connection as discussed above.

Pressure Validation Conclusions

The 84 m Centre Zone model validation results show a consistent offset in the nighttime HGL, but the mid-day HGLs are in acceptable agreement. This discrepancy suggests that there is a connection between Haney Main #2 and the 84 m Centre Zone that has an anomalously high-pressure set point or no pressure regulation. The field data suggests that the connection is closest to Sites 11 and 12, which are on either side of Dewdney Trunk Road around 232nd Street. Additional field data would need to be collected to confirm the 'unregulated connection' hypothesis and reduce the search area.

Despite the nighttime pressure discrepancy, the daytime fluctuations in pressures are in acceptable agreement between the field data and model in terms of both timing and magnitude. KWL therefore believe that demands, headlosses, and diurnal patterns are sufficiently accurate for master planning work.

Path: O:\0100-0199\173-164\430-GIS\MXD-Rp\173164_Figure7-1_PressureMonitoringLocations.mxd Date Saved: 17/06/2016 2:19:35 PM
 Author: RTaylor

Pressure Monitoring Sites		
Site	Location/Description	Pressure Zone
1	136th Ave.: 22620 136 Ave	84 m
2	207th St: 20686 120B Ave	84 m
3	225th St: 11555- 225 St	84 m
4	240th St: 11320 240 St	84 m
5	Albion Dike: 23402 Fisherman Rd	84 m
6	Cliff Avenue: 22010 Cliff Ave	84 m
7	Cutler: 21198 Cutler Place	84 m
8	Laity & 128 Ave: 128 Ave & 212 Alignment	84 m
9	S241: 12511 241 St	138 m
10	Tamarack Loop: 23680 108 Loop	84 m
11	Fern: 23291 - 132 Ave	84 m
12	236th St: 11692 - 236 St	84 m
13	Nelson Peaks:	96 m
14	Albion Pump Station Discharge	Supply

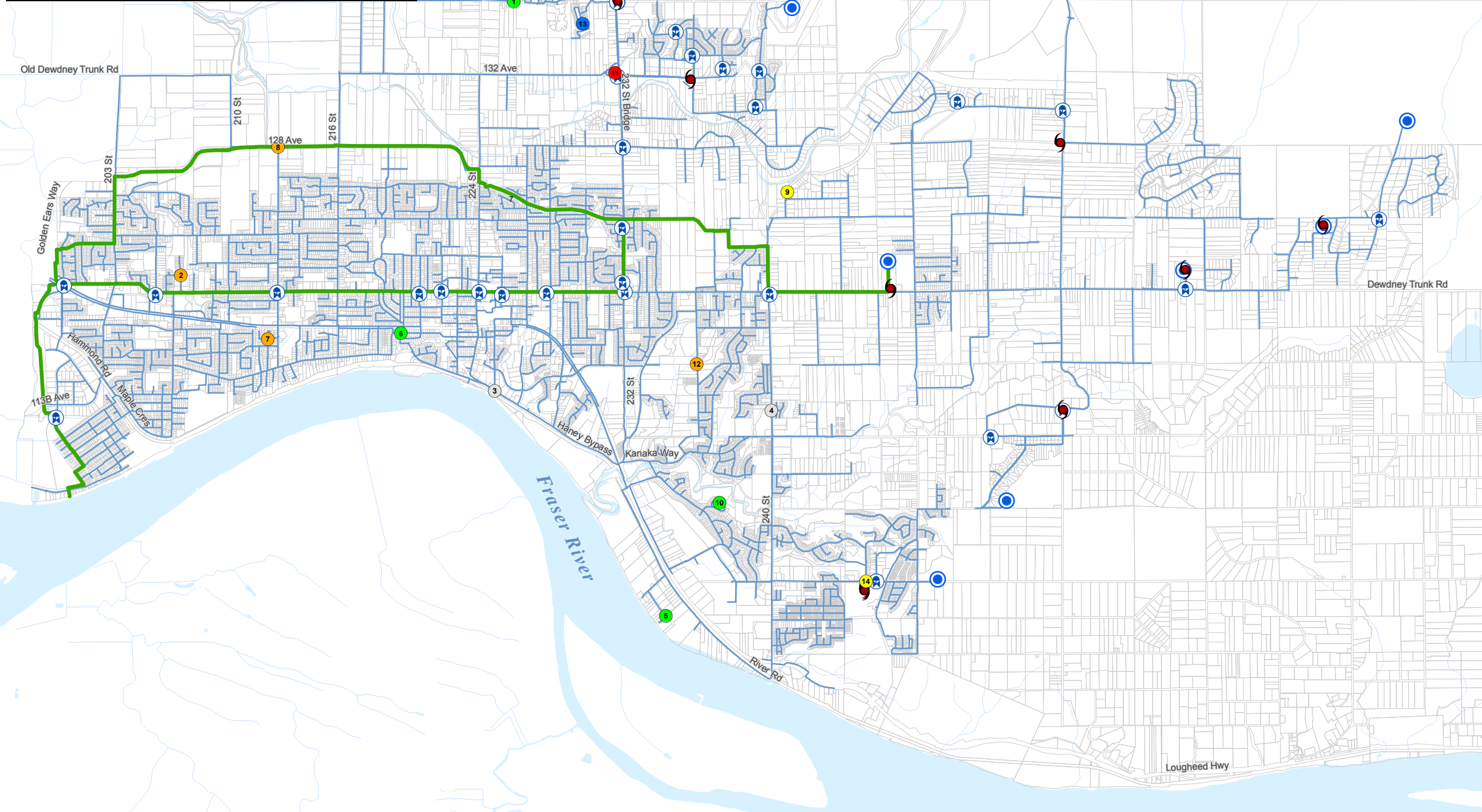

City of Maple Ridge Water Distribution Master Plan

Legend

- Existing Booster Pump Station
- Existing Reservoir
- Existing PRV
- Existing Transmission Main (MV) (≥600 mm)
- Existing Watermain (in Water Model)

Pressure Monitoring Site (Peak Hour Pressure)

Model Minus Field HGL (m)

- < -10
- 10 to -5
- 5 to 0
- 0 to 5
- 5 - 10
- N/A (No Data)



Copyright Notice: These materials are copyright of Kerr Wood Leidal Associates Ltd. (KWL). District of Maple Ridge is permitted to reproduce the materials for archiving and for distribution to third parties only as required to conduct business specifically relating to the Drinking Water Master Plan Update. Any other use of these materials without the written permission of KWL is prohibited.

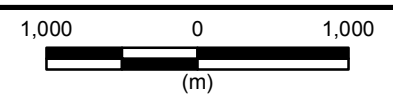

Project No. 173-164	Date June 2016
------------------------	-------------------

Pressure Monitoring Locations

Figure 7-1

Table 7-1: Summary and Comparison of Peak Hour SCADA Pressures to Water Model Pressures

Site	Location/Description	Model Junction	Pressure Zone	Average Field Peak Hour Pressure (psi)	Maximum Hourly Field Night Time Average Pressure (psi)	Elevation (m) ¹	Peak Hour Model Results		Peak Hour Difference		Night Time Model Results		Night Time Difference		Comments
							Pressure (psi)	HGL (m)	Model ±HGL (m)	Model ±% HGL	Pressure (psi)	HGL (m)	Model ±HGL (m)	Model ±% HGL	
1	136th Ave.: 22620 136 Ave	J-4947	84 m	112.4	126.6	5.1	110.6	82.9	-1.8	-1.6	117.6	87.8	-8.9	-7.1	
2	207th St: 20686 120B Ave	J-4115	84 m	104.2	119.6	13.5	95.3	80.5	-8.9	-8.5	104.4	86.9	-15.2	-12.7	
3 ³	225th St: 11555- 225 St	J-4754	84 m	n/a no data	n/a no data	6.5	n/a no data	86.9	n/a no data	n/a no data	116.9	88.7	n/a no data	n/a no data	
4	240th St: 11320 240 St	J-3982	84 m	n/a bad data	83.5	42.3	n/a bad data	88.2	n/a bad data	n/a bad data	66.8	89.3	-16.7	-20.0	
5	Albion Dike: 23402 Fisherman Rd	J-1769	84 m	119.4	129.4	3.5	119.1	87.3	-0.3	-0.3	121.6	89.1	-7.7	-6.0	
6	Cliff Avenue: 22010 Cliff Ave	J-4183	84 m	75.6	87.7	33.5	73.5	85.2	-2.1	-2.8	77.6	88.1	-10.1	-11.5	
7	Cutler: 21198 Cutler Place	J-3371	84 m	85.0	100.4	25.5	79.0	81.1	-6.0	-7.0	87.5	87.1	-12.9	-12.9	
8	Laity & 128 Ave: 128 Ave & 212 Alignment	J-MR020	84 m	115.3	130.4	7.0	107.2	82.4	-8.1	-7.1	114.4	87.4	-16.1	-12.3	
9	S241: 12511 241 St	J-2313	138 m	111.6	124.0	54.5	116.3	136.3	4.7	4.2	121.0	139.6	-2.9	-2.4	Pressure governed mostly by 265th St. Reservoir fill cycles
10	Tamarack Loop: 23680 108 Loop	J-4634	84 m	113.6	123.4	7.5	113.4	87.3	-0.2	-0.2	116.0	89.1	-7.4	-6.0	
11	Fern: 23291 - 132 Ave	J-636	84 m	105.6	115.1	16.8	93.7	82.7	-11.9	-11.3	100.9	87.8	-14.1	-12.3	
12	236th St: 11692 - 236 St	J-2725	84 m	71.7	80.3	42.7	63.6	87.5	-8.1	-11.3	66.2	89.3	-14.1	-17.6	
13	Nelson Peaks:	J-522	96 m	109.0	120.8	10.5	119.0	94.2	10.0	9.2	122.2	96.4	1.4	1.1	
14	Albion Pump Station Discharge	J-243	Supply	146	148.8	53.4	147.8	157.3	1.8	1.3	153.0	161.0	4.2	2.8	

¹ Elevations of pressure loggers are generally assumed to be 450 mm below ground surface except where the City has advised otherwise.

² Field HGL is calculated using the relationship: HGL = [Pressure (psi)] * [0.7030695783] + [Elevation (m)]

³ Data provided at this site were all 0 psi.

KERR WOOD LEIDAL ASSOCIATES LTD.

Consulting Engineers

\\ibra25.burnaby.kerrwoodleidal.org\0000-0999\0100-0199\173-164\400-Work\Pressure Validation\20160119-Pressure_Points_Jul_2013.xlsx\Table 7-1 20141027\PointsPH_p

Table 7-2: Summary and Comparison of Base Demand SCADA Pressures to Water Model Pressures

Site	Location/Description	Model Junction	Pressure Zone	Average Field Night Pressure (psi)	Elevation (m) ¹	Model Results		Model ±P (psi)	Model ±% P	Comments
						Pressure (psi)	HGL (m)			
1	136th Ave.: 22620 136 Ave	J-4947	84 m	126.1	5.1	120.4	89.7	-5.7	-4.6	
2	207th St: 20686 120B Ave	J-4115	84 m	115.3	13.5	108.1	89.5	-7.2	-6.3	
3 ³	225th St: 11555- 225 St	J-4754	84 m	n/a no data	6.5	n/a no data	89.9	n/a no data	n/a no data	
4	240th St: 11320 240 St	J-3982	84 m	n/a inaccurate data	42.3	n/a inaccurate data	90.0	n/a inaccurate data	n/a inaccurate data	
5	Albion Dike: 23402 Fisherman Rd.	J-1769	84 m	127.6	3.5	122.9	90.0	-4.7	-3.7	
6	Cliff Avenue: 22010 Cliff Ave	J-4183	84 m	84.5	33.5	79.9	89.7	-4.6	-5.4	
7	Cutler: 21198 Cutler Place	J-3371	84 m	96.8	25.5	91.1	89.6	-5.7	-5.9	
8	Laity & 128 Ave: 128 Ave & 212 Alignment	J-MR020	84 m	127.4	7.0	117.5	89.6	-9.9	-7.8	
9	S241: 12511 241 St	J-2313	138 m	120.0	54.5	117.7	137.2	-2.3	-1.9	
10	Tamarack Loop: 23680 108 Loop	J-4634	84 m	121.8	7.5	117.3	90.0	-4.5	-3.7	
11	Fern: 23291 - 132 Ave	J-636	84 m	n/a no data	16.8	n/a no data	89.7	n/a no data	n/a no data	
12	236th St: 11692 - 236 St	J-2725	84 m	77	42.7	67.3	90.1	-9.7	-12.6	
13	Nelson Peaks:	J-522	96 m	114.0	10.5	120.7	95.3	6.7	5.9	
14	Albion Pump Station Discharge	J-243	Supply	n/a no data	53.4	52.0	90.0	n/a no data	n/a no data	

¹ Elevations of pressure loggers are generally assumed to be 450 mm below ground surface except where the City has advised otherwise.

² Field HGL is calculated using the relationship: HGL = [Pressure (psi)] * [0.7030695783] + [Elevation (m)]

³ Data provided at this site were all 0 psi.

KERR WOOD LEIDAL ASSOCIATES LTD.

Consulting Engineers

\\ibra25.burnaby.kerrwoodleidal.org\0000-0999\0100-0199\173-164\400-Work\Pressure Validation\20160119Pressure_Points_Jan_2013.xlsx\Table 7-2 20141028PointsNig_P



8. Design Criteria

8.1 Boundary Conditions

The principal boundary in the model is the supply HGL on Haney Main #2 and #3 from MV at the City's western border.

Base Demand Boundary Conditions

Metro Vancouver has an agreement with the City to maintain at least 84 m HGL at Dewdney Trunk Road and 230th Street, however typically the HGL at this location is between 94 and 96 m HGL to maintain water levels in the 246 Street Maple Ridge Reservoir. Consequently, the HGLs at the boundary range between 94 m and 114 m. See Appendix D-15: 'Metro Vancouver Supply Pressure January 2013 at Lougheed Highway and Dewdney Trunk Road' for representative base demand data.

For base demand scenarios, an HGL of 106 m was selected for the Haney Main #2 and #3 boundaries in order to maintain at least 96 m HGL at DTR & 230th Street as well as maintain the Maple Ridge Reservoir levels for extended period simulations.

Max Day Demand Boundary Conditions

During high demand periods, the supply HGL at Lougheed Hwy and Dewdney Trunk Road range from 102 m to 127 m HGL. See Appendix D-16: *Metro Vancouver Supply Pressure July 24 to 31, 2013 at Lougheed Highway and Dewdney Trunk Road* for representative max day demand data.

For max day demand scenarios, an HGL was selected for the Haney Main #2 and #3 boundaries in order to maintain at least 96 m HGL at DTR and 240th Street as well as result in cycling of the Maple Ridge Reservoir (246 Street Reservoir) for extended period simulations.

The supply HGL for Haney Main #2 and #3 used for each time horizon is as follows:

- Existing (Design) – 102 m HGL;
- 2018 – 104 m HGL;
- 2023 – 106 m HGL; and
- 2041 – 109 m HGL.

It should be noted that the ability of the Metro Vancouver transmission system to meet the City's demands for existing and future conditions has not been assessed as part of this study.

8.2 Pump Station Capacity

The supply capacity for each of the City's pump stations was assessed using the firm capacity of the station (i.e., assumes largest pump is out of service). Refer to Appendix E for a detailed review of the capacity of each pump station.



8.3 Required Reservoir Storage

Reservoir storage requirements were assessed using the following MMCD Design Guideline Manual (2005) recommended total storage volume equation. Refer to Appendix E for a detailed review of the storage requirement for each reservoir.

Total Volume = A + B + C
 where A = Fire Storage Volume = Required Fire Flow x Duration
 B = Equalization Volume = MDD x 25%
 C = Emergency Storage Volume = 0.25 x (A + B)

8.4 Pressure

Pressure criteria are as follows:

- Minimum pressure during PHD = 300 kPa (44 psi);
- Minimum pressure during MDD + Fire Flow = 150 kPa (20 psi);
- Maximum pressure (existing developments) = 1,035 kPa (150 psi); and
- Maximum pressure (new developments) = 900 kPa (130 psi).

8.5 Fire Flow

The City's Design Criteria Manual specifies required fire flows for each land use zoning type; refer to Table 8-1 below.

Table 8-1: Required Fire Flow by Land Use Zoning Type

Type of Constructions	Required Fire Flow (L/s)
Single-Family Residential	60
Multi-Family Residential ¹	120
Institutional	150
Commercial	150
Industrial	225
Note: Prior to the 2015 Design Criteria Manual, required fire flow for MF Residential was 90 L/s.	

8.6 Water Mains

The City's Design Criteria Manual specifies the following for water mains:

- maximum flow velocity of 1.0 m/s during MDD or PHD; and
- minimum 200 mm dia. when servicing fire hydrants.

It is noted that this criteria was applied to the sizing of new infrastructure only.

8.7 Pump Stations

For the purpose of determining preliminary pump station sizes, the required brake horsepower has been derived while allowing for the following factors:

1. Efficiency Factor = 0.8, accounts for pump efficiency; and
2. Oversize Factor = 0.7, accounts for pump oversizing during selection and redundancy added during design (e.g., extra pump).



9. Cost Opinions

9.1 Unit Rates

Cost opinions for the capital projects identified as part of this master plan were developed based on unit rates for typical construction items. Refer to Table 9-1 below.

Table 9-1: Unit Rates for Cost Opinions

Item	Unit	Typical Unit Costs
150 mm dia. water main	lin. m	\$380
200 mm dia. water main	lin. m	\$415
250 mm dia. water main	lin. m	\$465
300 mm dia. water main	lin. m	\$525
350 mm dia. water main	lin. m	\$565
400 mm dia. water main	lin. m	\$625
Fire hydrant	ea.	\$6,000
Water main tie-in to existing system	ea.	\$6,500
Pump station (>300 hp)	hp	\$6,700
Pump station (<300 hp)	hp	\$9,700
Pressure reducing station (new, per valve)	ea.	\$100,000
Pressure reducing station (upgrade)	ea.	\$55,000
Bolted steel reservoir (<2,000 m ³)	m ³	\$1,200
Concrete reservoir (<2,000 m ³)	m ³	\$1,300
Concrete reservoir (>2,000 m ³)	m ³	\$865

The rates include allowances for engineering (20%) and contingency (30%). Taxes are excluded from the unit rates. The rates have been established based on 2015 construction costs, and do not include an allowance for cost escalation for projects completed in future years.

The water main unit rates allow for standard pavement restoration and traffic control. Costs for property and ROW acquisition have not been included in the unit rates.

The cost opinions are indicative only and have been prepared for long-term budgeting purposes only. They are based on existing mapping and topography in conjunction with KWL's experience. No site surveys or assessments were completed for these estimates.

Unit prices are based on recent costs for similar facilities, however, no detailed quantity take-offs or equipment selection has been completed. Unit rates for water mains are based on typical construction parameters and average depth of bury. Project budgets for each task require refinement based on scoping from a pre-design study and site survey.



10. Evaluation of System

10.1 Summary

The Maple Ridge water distribution system was evaluated by completing the following steps:

1. Reviewed the existing reservoir storage capacities and compared to current and future requirements;
2. Reviewed the existing pump station capacities and compared to current and future requirements;
3. Completed a hydraulic analysis using the City's water model to determine available fire flows, and compared to the design criteria requirements for fire flow based on land use type;
4. Completed a hydraulic analysis using the City's water model to determine peak hour pressures, and compared to the bylaw requirement of 300 kPa (44 psi); and
5. Reviewed the water distribution system with consideration to redundancy (such as water main looping) and operational issues.

Water quality considerations are addressed in a separate memorandum.

10.2 Reservoir Storage Volumes

Refer to Appendix E for detailed calculations of the recommended reservoir storage volumes, based on the current and future demands of each reservoir's servicing area. Note that design standards may have changed since the original construction of some reservoirs; the current MMCD standard for reservoir sizing has been used in this report. A summary of existing reservoir volumes compared to MMCD design volumes is presented in Table 10-1 below; deficits are highlighted with red text.

Note: in some cases, the lack of storage is offset by additional pump capacity. These cases are highlighted in green text.



Table 10-1: Summary of Reservoir Volumes (Existing and MMCD Design)

Reservoir Name	Existing Volume ¹ (m ³)	Existing Design Volume (m ³)	2018 Design Volume (m ³)	2023 Design Volume (m ³)	2041 Design Volume (m ³)	2041 Service Area
Albion	1,954	1,489	1,788	1,962	2,322 ²	158 m Albion/112 m Albion Sub-zone
Rockridge (Silver Valley)	4,000	2,082	2,485	2,687	3,453	176 m Silver Valley/176 m Rockridge/140 m Lower Silver Valley/122 m Fern
263 Street	3,925	5,028	4,971	5,040	5,309	138 m East ³ – Note: 263 St storage supplemented by 256 St&270A St reservoirs, and by excess pump capacity at 246 St Pump Station.
256 Street & 270A	3,132	3,735	4,371	4,693	5,864	241 m NE (North)/241 m NE (South)/171 m 130 Avenue/171 m Tretheway; Note: Storage capacity supplemented by excess pump station capacity at 256 St and 263 St PS's until 2023.
McNutt Road	633	740	943	1,067	1,516	329 m Garibaldi/293 m Rothsay
Grant Mountain	765	403	503	550	735	224 Grant Mountain/158 m Lower Grant
Notes:						
1. Existing Volume includes storage from reservoirs in zone, plus additional storage available from upper zone(s) if a PRV connection exists (additional storage amount includes upper zone surplus storage plus fire flow amount only)						
2. A future school may be serviced by the Albion Zone in the 2041 timeframe according to DMR staff, which would increase required fire flow to 150 L/s and result in a 2041 Design Volume of 2,592 m ³ .						
3. The demand calculation for the 138 m East Zone over-estimates the demands as compared to that seen in past SCADA records. A future water use study should be undertaken to further refine existing flows for future water model use. Also refer to the Urban Systems report "138 m and 241 m Zone Storage and Optimization Study" (October 2013).						

Notes regarding storage capacity are summarized in Table 10-2 below.

Table 10-2: Storage Reservoir Notes

Note No.	Reservoir Name	Timeline	Description
S-02	Rockridge (Silver Valley)	Existing	The second Rockridge Reservoir (2,600 m ³) was completed in 2016 and is now operational.
S-03	Albion	Existing	The Grant Mountain Reservoir was purposely oversized to provide storage for the Albion Zone. The design and construction of a connection between the Grant Mountain Reservoir and the Albion Zone was completed in late 2016. In addition, the Albion Pump Station capacity currently exceeds maximum day demands, reducing the required balancing component.
S-04	256 Street & 270A Street	Existing	Existing capacity is less than the MMCD design storage capacity. It is also noted that the combined capacity of the 256 and 263 Street pump stations currently exceed maximum day demands, which reduces the balancing requirement. In addition, design and construction of a new reservoir cell at 270A Street is underway in 2016 - 2017.



Note No.	Reservoir Name	Timeline	Description
S-06	263 Street	Existing	Existing storage of the 263 St Reservoir is less than the design capacity. However, the model demand calculation for the 138 m East Zone over-estimates the demands as compared to that seen in past SCADA records. A future water use study should be undertaken to further refine existing flows for future water model use (Also refer to the Urban Systems report "138 m and 241 m Zone Storage and Optimization Study"). Further, A PRV connection exists to provide upstream storage capacity from 256/270A St Reservoirs. An additional PRV station is recommended to strengthen this connection. Excess capacity at the 246 Street MV Pump Station has also been considered in the reservoir sizing analysis.
S-07	McNutt Road	Existing	The existing McNutt Reservoir storage is less than the design capacity for the Garibaldi and Rothsay zones. Design and construction of an additional reservoir cell is underway in 2016/2017.

Reservoir projects to address the above items are found in Section 11.1 on page 11-1.

10.3 Pump Station Capacities

Refer to Appendix E for detailed calculations of the required pump station capacities, based on the current and future demands of each pump station's servicing area.

A summary of existing pump station firm capacity versus current/future demands is presented in Table 10-3 below; deficits are highlighted with red text.

Table 10-3: Summary of Pump Station Capacities

Pump Station Name	Existing Firm Capacity (L/s)	Existing Estimated Demand (L/s)	2018 Estimated Demand (L/s)	2023 Estimated Demand (L/s)	2041 Estimated Demand (L/s)
236 Street	68	27	42	50	78
246 Street	280	123	156	177	258
256 Street & 263 Street	96 ¹¹	44	75	92	152
Albion	47	15	26	33	46
270A	15	13	21	26	42
Grant Mountain	19	1	5	6.4	13.2

Notes regarding pump station capacities are summarized in Table 10-4.

¹¹ Assumes largest pump between the two combined stations is out of service.



Table 10-4: Pump Station Notes

Note No.	Pump Station Name	Timeline	Description
P-01	256 Street & 263 Street	Future – 2041	The combined 256 Street and 263 Street pump stations may require capacity upgrades to service the estimated 2041 demands.
P-02	270A	Future – 2018	Upgrades are recommended to 270A pump station to service the Maple Benchlands Development. To service buildout of the zone, construction of a new pumpstation is recommended.
P-03	236 Street	Future – 2041	Capacity upgrades may be required to meet the estimated 2041 demands of the Silver Valley water servicing area.

Pump Station projects to address the above items are found in Section 11.2 on page 11-3.

10.4 Hydraulic Model Analysis

A hydraulic analysis of the water distribution system was completed using the updated Maple Ridge water model in order to assess system performance (available pressure and fire flow). The water model analysis utilized scenarios for the existing design condition, as well as for years 2018, 2023, and 2041 and specific scenarios for optional growth and development (e.g., Thornhill Urban Reserve). Results for peak hour pressure and available fire flow from each timeline/scenario were compared to the City's design criteria.

Issues that may require capital work to address are presented in Table 10-5. A full list of hydraulic notes is included in Appendix F.

Existing water mains of less than 150 mm diameter have been excluded from the fire flow results, as these are assumed to be domestic services and not connected to fire hydrants. Also, available fire flows are reported at model nodes, which do not correspond directly to hydrant locations. In particular, modelled low available fire flows are often misrepresentative at dead end mains. Engineering judgement is required to assess pressure and fire flow deficiencies indicated by a model.

Figure 10-1 presents the peak hour pressure model results for existing conditions, while Figure 10-2 presents available fire flows during existing conditions.

Figure 10-3 presents the maximum static (i.e., nighttime) pressure for existing conditions.

Figures 10-4 through 10-9 present peak hour pressures and available fire flows for the various future time horizons used in the analysis, with no system upgrades in place.

Low peak hour pressure has been defined as less than 44 psi, which is suggested in MMCD design criteria. It is noted however that many jurisdictions use 40 psi as a target for minimum pressure. Whereas 44psi is used as an indicator of a potential issue to address, engineering judgement is required to determine if improvement is required for any specific case.



Table 10-5: Hydraulic Assessment Notes¹²

Note No.	Type	Pressure Zone	Timeline	Description	Addressed by Project (Section 11)
H-01	Pressure	84 m Centre	Existing	Low peak hour pressure (40 psi) is noted at the end of 126 Avenue east of 238 Street.	2015-05
H-03	Pressure	112 m Albion Sub-zone	Existing	Low peak hour pressure (40 psi) is noted at the bulk filling station on Jackson Road, at the north end of the 245B Street main.	2015-17
H-09	Pressure	84 m Centre	Existing	The existing 240 Street PRV is undersized for PHD based on 2014 field testing (refer to Appendix C for details).	2015-06
H-24	Fire Flow	84 m Centre	Existing	Fire flow is marginally below design value on 241A Street, north of 113 Avenue. Available fire flow = 51 L/s, design fire flow = 60 L/s.	2015-18
H-25	Fire Flow	84 m Centre	Existing	Fire flow is below design value on Cameron Court, north of 110 Avenue. Available fire flow = 44 L/s, design fire flow = 60 L/s.	2015-14
H-26	Fire Flow	112 m Albion Sub-zone	Existing	Fire flow is low on 245B Street, north of 104 Avenue. Available fire flow = 55 L/s, 60 L/s design.	2015-17
H-27	Fire Flow	84 m Centre	Existing	Fire flows are low south of 128 Ave between 235 Street and 239 Street. Available fire flow = 32-50 L/s, design fire flow = 60 L/s.	2015-50
H-28	Fire Flow	84 m	Existing	Fire flow is below design value at the west end of Wharf Street. Available fire flow = 154 L/s, design fire flow = 225 L/s.	2015-62
H-30	Fire Flow	84 m Centre	Existing	Fire flow is below design value on 136 Avenue west of Foreman Drive. Available fire flow = 38 L/s, design fire flow = 60 L/s.	2015-08
H-32	Fire Flow	138 m East	Existing	Fire flow is below design value on 124 Avenue, east of 256 Street. Available fire flow = 37 L/s, design fire flow = 60 L/s. Existing main also long dead-end AC section.	2015-24
H-33	Fire Flow	138 m East	Existing	Fire flow is marginally below design value on 116 Avenue, east of 260 Street. Available fire flow = 58 L/s, design fire flow = 60 L/s.	2015-16
H-34	Fire Flow	84 m Centre	Existing	Fire flow is marginally below design value at the south end of Fisherman Dr., south of River Rd. Available fire flow = 169 L/s, design fire flow = 225 L/s.	2015-23
H-50	Fire Flow	84 m Centre	Existing	Fire flow is below design value on 245 Street, north of 104 Avenue. Available fire flow = 135 L/s, design fire flow = 150 L/s.	2015-06
H-47	Fire Flow	84 m Centre	Future – 2041	Fire flows are lower than design value within the industrial area around Kingston Street and 113B Street. Available fire flow = 170 L/s (typical), design fire flow = 225 L/s.	2015-62

¹² Notes were developed, re-ordered, and in some cases removed as the study progressed. Numbers that appear to be missing or out of order are intentional.



10.5 Redundancy Review

The existing system was reviewed with respect to supply and delivery of water to and from the system facilities. Notes are summarized in Table 10-6 below.

Table 10-6: Redundancy Notes

Note No.	Pressure Zone	Timeline	Description
R-01	329 m Garibaldi	Future – 2041	Supply to the majority of the zone is via a single main.
R-02	329 m Garibaldi	Future – 2041	Supply to the McNutt Reservoir is via a single main.
R-03	158 m Albion	Existing	Note: a connection between the Grant Mountain Reservoir and the 158 m Albion Zone was completed in late 2016. The existing Grant Mountain Reservoir was built to provide balancing and fire storage support for Albion
R-04	138 m East	Future – 2041	Supply to the 256 Street Pump Station is via a single main.
R-05	241 m NE	Future – 2041	Supply to the 270A Reservoir is via a single main.

Projects to address the above redundancy items are found in Section 11.4 on page 11-6.

10.6 Miscellaneous Review Items

Miscellaneous items of interest noted by KWL during the study are summarized in Table 10-7 below.

Table 10-7: Other Review Items





Concern No.	Pressure Zone	Timeline	Description
O-02	84 m Centre	Future - 2018	Vulnerable sections of the River Road transmission main have been identified as being subject to potential soil liquefaction in previous studies. Liquefaction could cause significant damage to the local water mains in the event of an earthquake.
O-03	Various	Existing	Approximately 56 km of asbestos cement pipe exists within the water system. All AC pipe has previously been slated for replacement.
O-04	84 m Centre	Future	The existing PRV stations along Dewdney Trunk Road servicing the 84 m Centre Zone do not include flow meters. It is anticipated that flow meters would only be installed at such time as the existing PRV stations are being replaced.

Projects to address the above miscellaneous items are found in Section 11.5 on page 11-8.







Path: C:\0100-0199\173-164\430-GIS\MXD-Rp173164_Figure10-1_PeakHrDemandPressure_ExistingSystem.mxd Date Saved: 17/06/2016 2:19:58 PM Author: R.Taylor

City of Maple Ridge Water Distribution Master Plan

Legend

-  Existing Water Main
-  Existing Booster Pump Station
-  Existing Reservoir
-  Existing PRV

Peak Hour Pressure (psi)

-  < 20
-  20 - 44
-  44 - 60
-  60 - 80
-  80 - 150
-  > 150

Pressure Zone

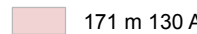
- | | |
|--|--|
|  84 m Centre |  158 m Lower Grant |
|  96 m Centre Subzone |  171 m 130 Ave |
|  122 m Fern |  171 m Tretheway |
|  138 m East |  176 m Silver Valley |
|  140 m Silver Valley West |  224 m Grant Mountain |
|  158 m Albion |  241 m NE |
| |  293 m Rothsay |
| |  329 m Garibaldi |



Copyright Notice: These materials are copyright of Kerr Wood Leidal Associates Ltd. (KWL), City of Maple Ridge is permitted to reproduce the materials for archiving and for distribution to third parties only as required to conduct business specifically relating to the Drinking Water Master Plan Update. Any other use of these materials without the written permission of KWL is prohibited.

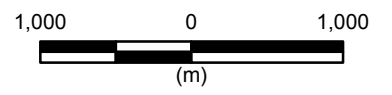

Project No. 173-164	Date June 2016
------------------------	-------------------



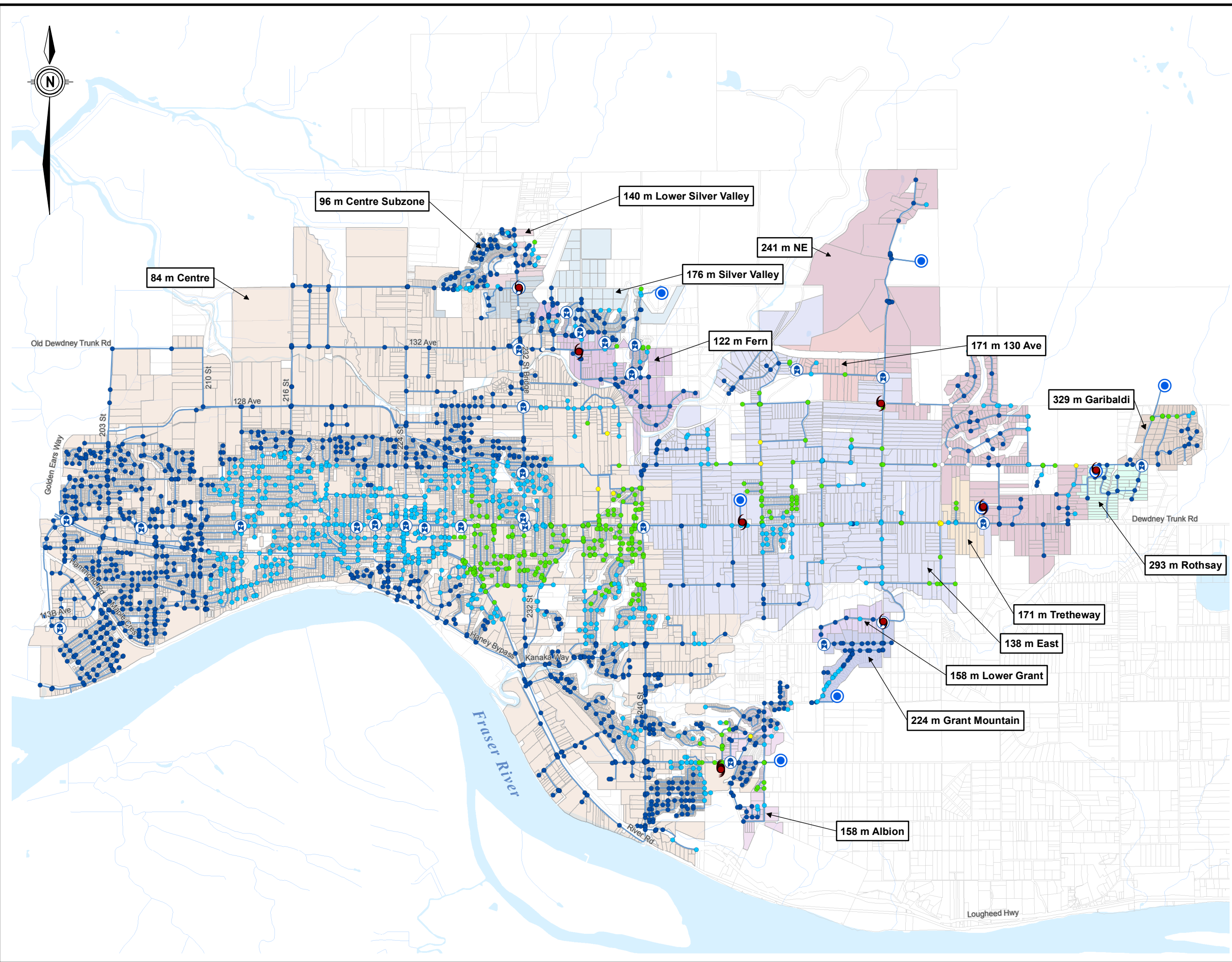

Peak Hour Demand Pressures Existing (Design) System

Figure 10-1







City of Maple Ridge Water Distribution Master Plan





Legend

-  Water Main
-  Existing Booster Pump Station
-  Existing Reservoir
-  Existing PRV

Available Fire Flow (L/s)

-  0 - 60
-  60 - 120
-  120 - 150
-  150 - 225
-  > 225

Zoning Type / Required Fire Flow

-  Single Family Residential (60 L/s)
-  Multi-Family Residential (120 L/s)
-  Commercial / Institutional (150 L/s)
-  Industrial (225 L/s)

Criteria for Pressure at Required Fire Flow :
 Minimum residual pressure 150 kPa (22 psi)
 Minimum zone pressure 150 kPa (22 psi)

Note: Available fire flow refers to model node results, which do not correspond directly with fire hydrant flows. Engineering judgement is required to identify fire flow deficiencies.



Copyright Notice: These materials are copyright of Kerr Wood Leidal Associates Ltd. (KWL). City of Maple Ridge is permitted to reproduce the materials for archiving and for distribution to third parties only as required to conduct business specifically relating to the Drinking Water Master Plan Update. Any other use of these materials without the written permission of KWL is prohibited.

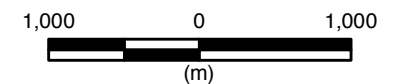



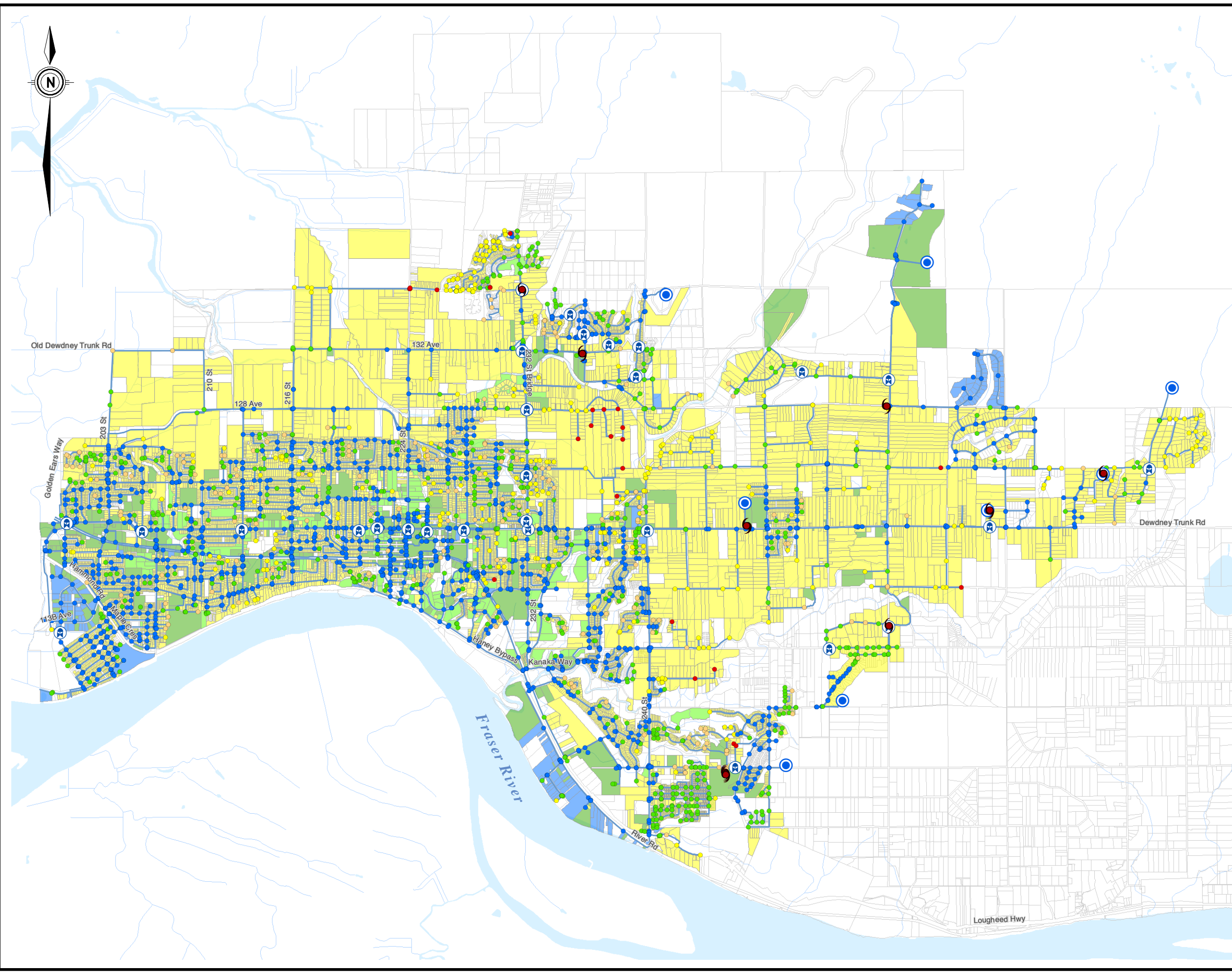

Project No. 173-164	Date November 2016
------------------------	-----------------------

**Available Fire Flow
Results
Existing (Design) System**
Figure 10-2





City of Maple Ridge Water Distribution Master Plan





Legend

-  Existing Water Main
-  Existing Booster Pump Station
-  Existing Reservoir
-  Existing PRV

Static (Night-Time) Pressure (psi)

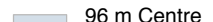
-  < 130
-  130 - 150
-  > 150

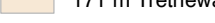
Pressure Zone

- | | | | |
|---|--------------------------|---|----------------------|
|  | 84 m Centre |  | 158 m Lower Grant |
|  | 96 m Centre Subzone |  | 171 m 130 Ave |
|  | 122 m Fern |  | 171 m Tretheway |
|  | 138 m East |  | 176 m Silver Valley |
|  | 140 m Silver Valley West |  | 224 m Grant Mountain |
|  | 158 m Albion |  | 241 m NE |
| | |  | 293 m Rothsay |
| | |  | 329 m Garibaldi |

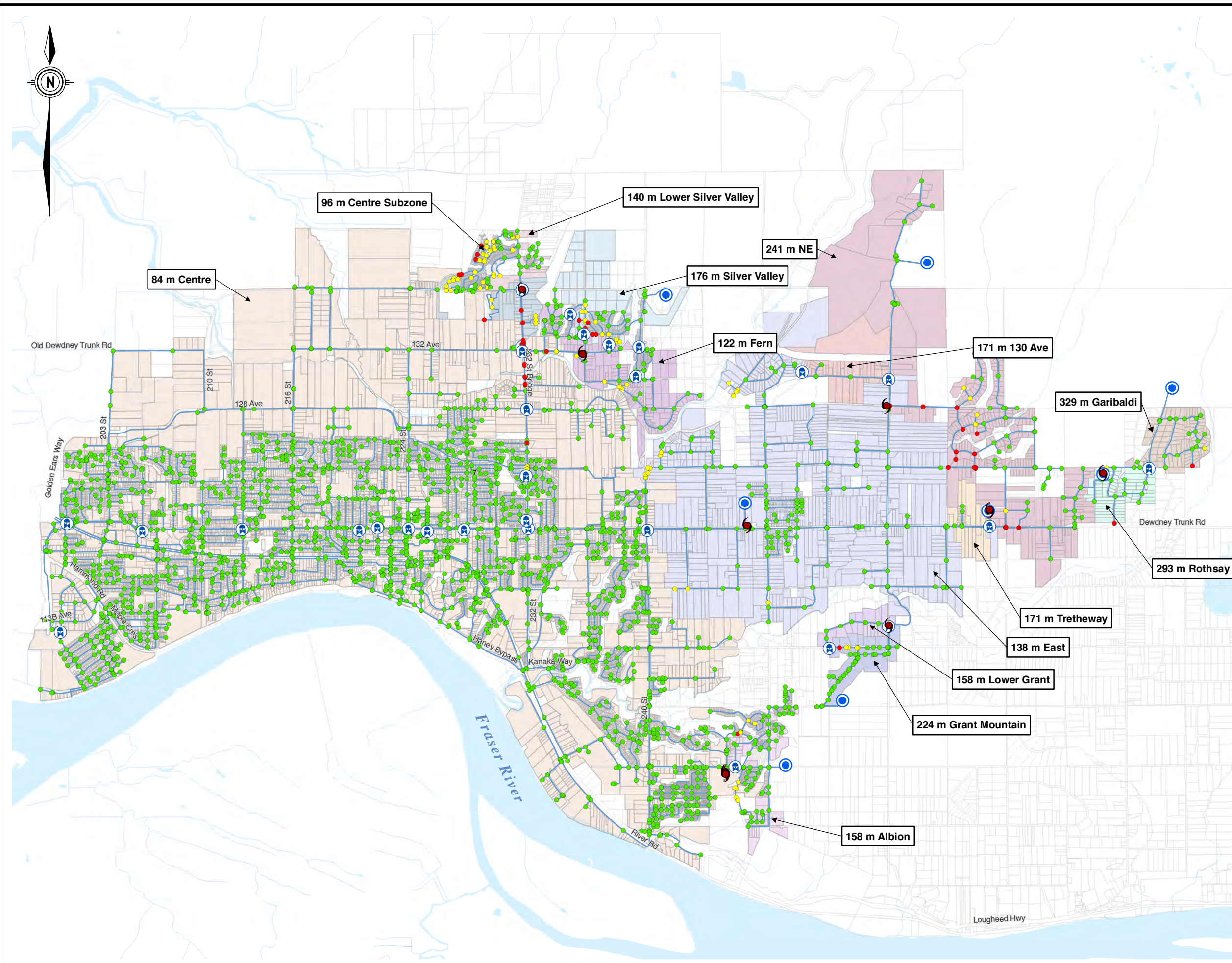

Copyright Notice: These materials are copyright of Kerr Wood Leidal Associates Ltd. (KWL), City of Maple Ridge is permitted to reproduce the materials for archiving and for distribution to third parties only as required to conduct business specifically relating to the Drinking Water Master Plan Update. Any other use of these materials without the written permission of KWL is prohibited.

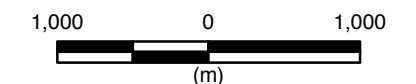

Project No.
173-164

Date
June 2016

**Static (Night-Time)
Pressures
Existing (Design) System**

Figure 10-3

Path: C:\0100-0199\173-164\430-GIS\MXD-Rp173164_Figure10-4_PeakHourDemandPressure_2018\System.mxd Date Saved: 17/06/2016 2:28:07 PM
 Author: FTaylor

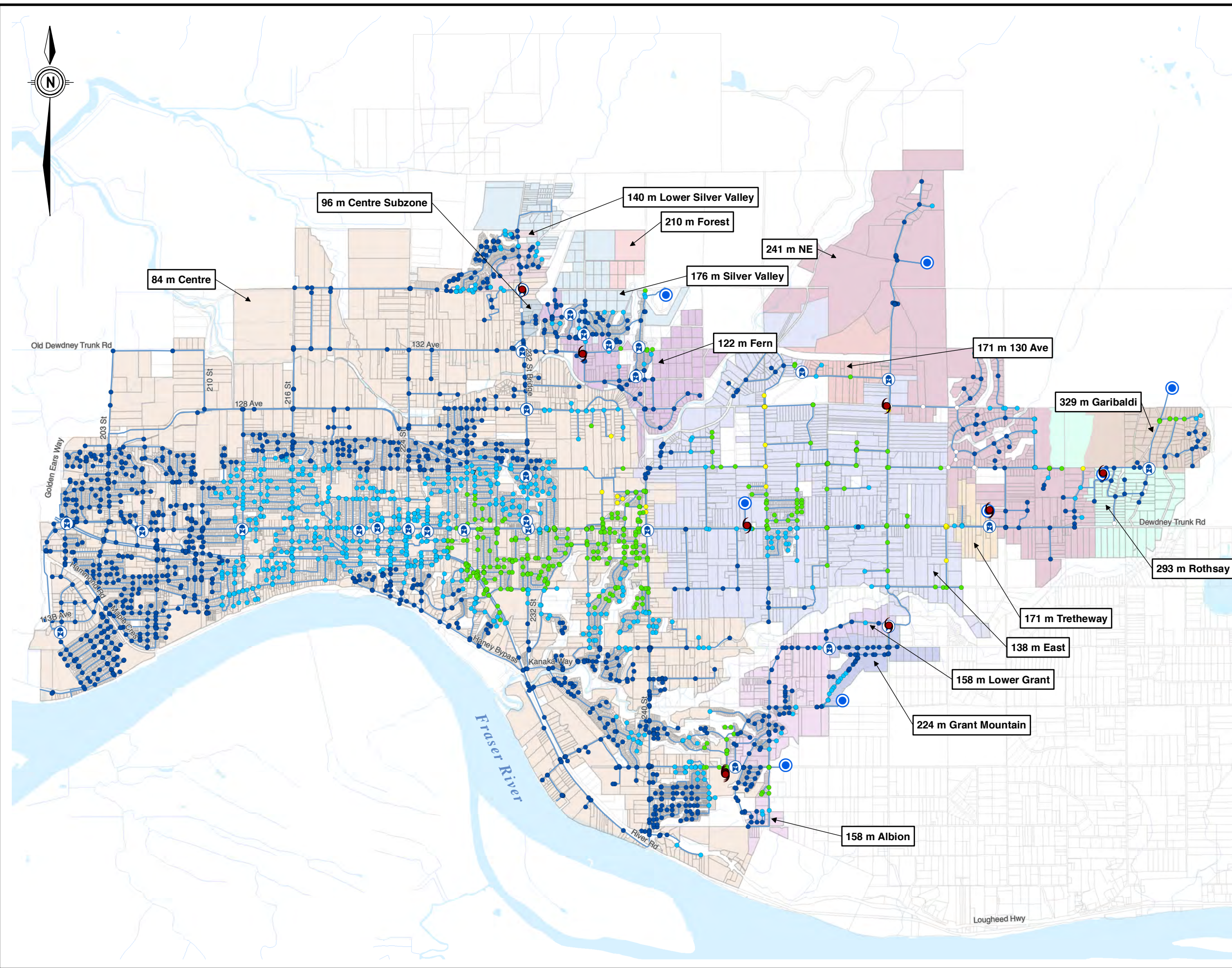

City of Maple Ridge Water Distribution Master Plan

Legend

- Water Main
- Existing Booster Pump Station
- Existing Reservoir
- Existing PRV

Peak Hour Pressure (psi)

- < 20
- 20 - 44
- 44 - 60
- 60 - 80
- 80 - 150
- > 150

Pressure Zone

- | | | | |
|--|--------------------------|--|----------------------|
| | 84 m Centre | | 171 m 130 Ave |
| | 96 m Centre Subzone | | 171 m Tretheway |
| | 122 m Fern | | 176 m Silver Valley |
| | 138 m East | | 210 m Forest |
| | 140 m Silver Valley West | | 224 m Grant Mountain |
| | 158 m Albion | | 241 m NE |
| | 158 m Lower Grant | | 293 m Rothsay |
| | | | 329 m Garibaldi |



Copyright Notice: These materials are copyright of Kerr Wood Leidal Associates Ltd. (KWL), City of Maple Ridge is permitted to reproduce the materials for archiving and for distribution to third parties only as required to conduct business specifically relating to the Drinking Water Master Plan Update. Any other use of these materials without the written permission of KWL is prohibited.

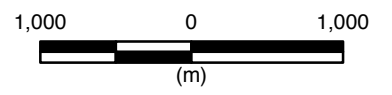

Project No.
173-164



Date
June 2016

Peak Hour Demand Pressures 2018 System

Figure 10-4

City of Maple Ridge Water Distribution Master Plan

Legend

-  Water Main
 -  Existing Booster Pump Station
 -  Existing Reservoir
 -  Existing PRV
- Available Fire Flow (L/s)
-  0 - 60
 -  60 - 120
 -  120 - 150
 -  150 - 225
 -  > 225
- Zoning Type / Required Fire Flow
-  Single Family Residential (60 L/s)
 -  Multi-Family Residential (120 L/s)
 -  Commercial / Institutional (150 L/s)
 -  Industrial (225 L/s)

Criteria for Pressure at Required Fire Flow :
 Minimum residual pressure 150 kPa (22 psi)
 Minimum zone pressure 150 kPa (22 psi)

Notes: Available fire flow refers to model node results, which do not correspond directly with fire hydrant flows. Engineering judgement is required to identify fire flow deficiencies.

Available fire flow results demonstrate the effect of assumed growth rates should corresponding system upgrades not be implemented.



Copyright Notice: These materials are copyright of Kerr Wood Leidal Associates Ltd. (KWL). City of Maple Ridge is permitted to reproduce the materials for archiving and for distribution to third parties only as required to conduct business specifically relating to the Drinking Water Master Plan Update. Any other use of these materials without the written permission of KWL is prohibited.

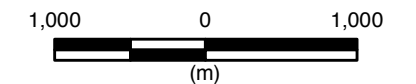

Project No. 173-164	Date November 2016
------------------------	-----------------------

Available Fire Flow Results 2018 System

Figure 10-5

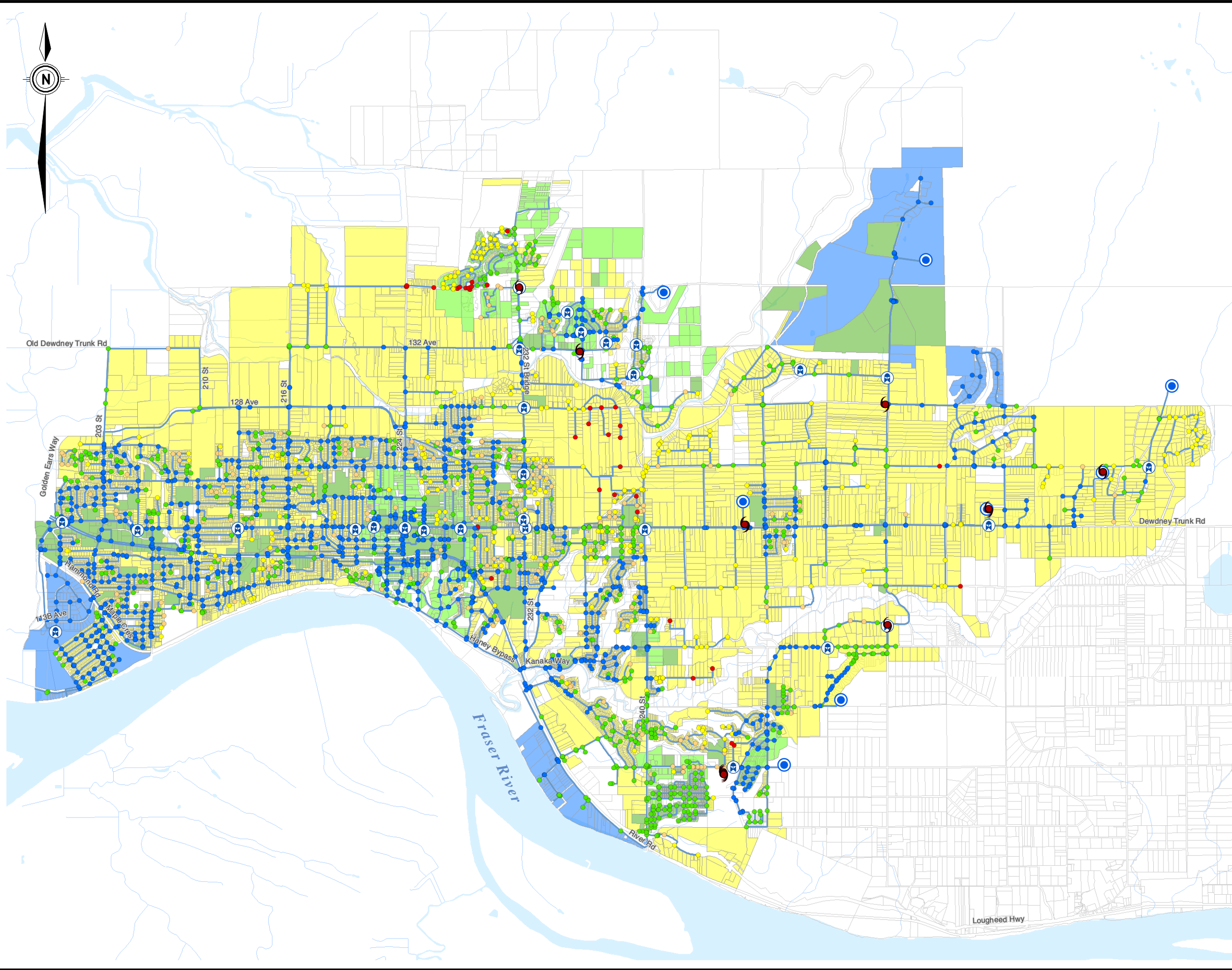

Path: C:\0100-0199\173-164\430-GIS\MXD-Rp173164_Figure10-6_PeakHourDemandPressure_2023\System.mxd Date Saved: 17/06/2016 2:35:04 PM Author: FTaylor

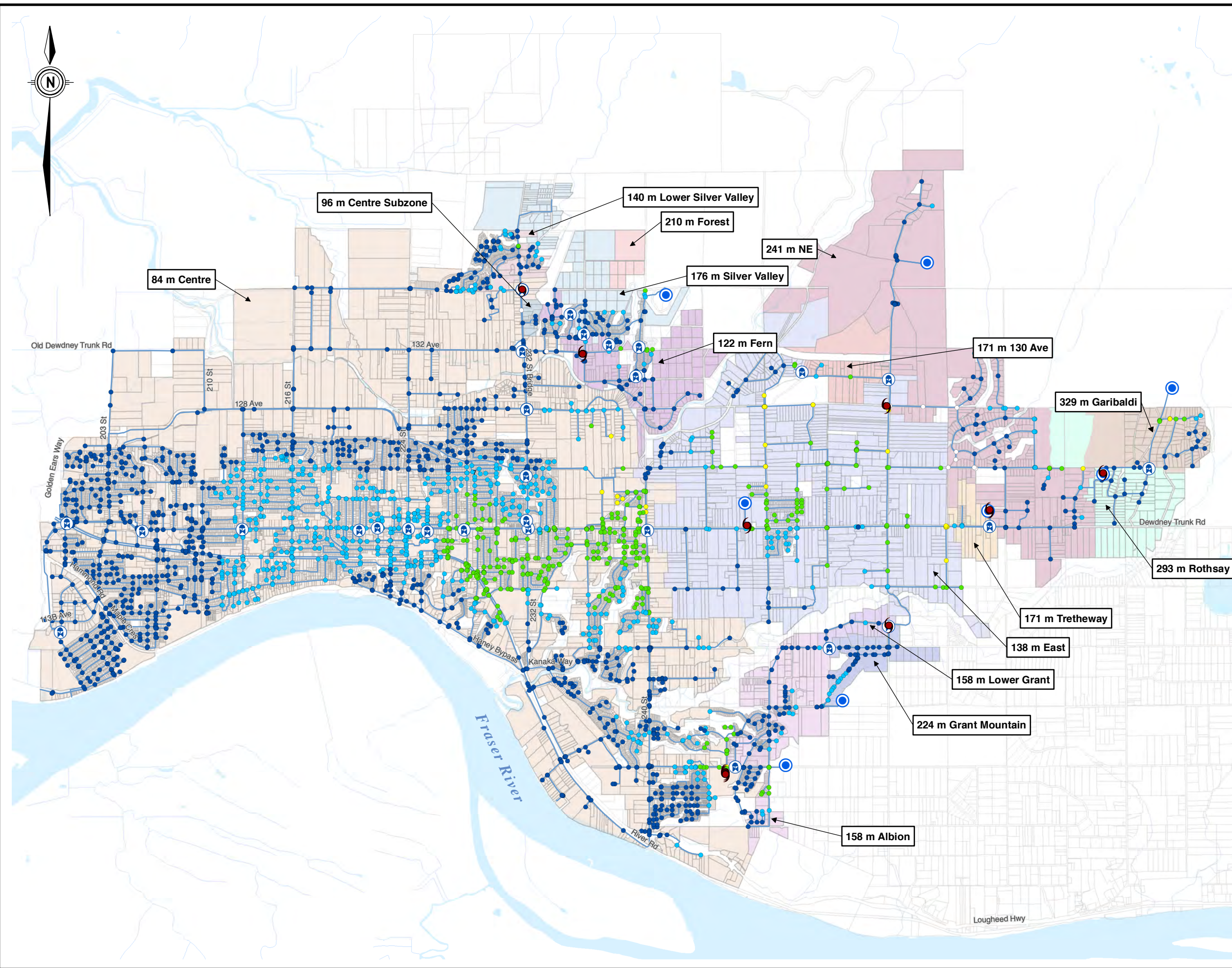

City of Maple Ridge Water Distribution Master Plan

Legend

- Water Main
- Existing Booster Pump Station
- Existing Reservoir
- Existing PRV

Peak Hour Pressure (psi)

- < 20
- 20 - 44
- 44 - 60
- 60 - 80
- 80 - 150
- > 150

Pressure Zone

- | | | | |
|--|--------------------------|--|----------------------|
| | 84 m Centre | | 171 m 130 Ave |
| | 96 m Centre Subzone | | 171 m Tretheway |
| | 122 m Fern | | 176 m Silver Valley |
| | 138 m East | | 210 m Forest |
| | 140 m Silver Valley West | | 224 m Grant Mountain |
| | 158 m Albion | | 241 m NE |
| | 158 m Lower Grant | | 293 m Rothsay |
| | | | 329 m Garibaldi |



Copyright Notice: These materials are copyright of Kerr Wood Leidal Associates Ltd. (KWL), City of Maple Ridge is permitted to reproduce the materials for archiving and for distribution to third parties only as required to conduct business specifically relating to the Drinking Water Master Plan Update. Any other use of these materials without the written permission of KWL is prohibited.

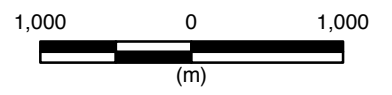

Project No. 173-164	Date June 2016
------------------------	-------------------

Peak Hour Demand Pressures 2023 System

Figure 10-6

Path: O:\0100-0199\173-164\430-GIS\MXD-Rp173164_Figure10-7_AvailableFireFlow_2023\System.mxd Date Saved: 11/18/2016 2:44:32 PM
 Author: tsch

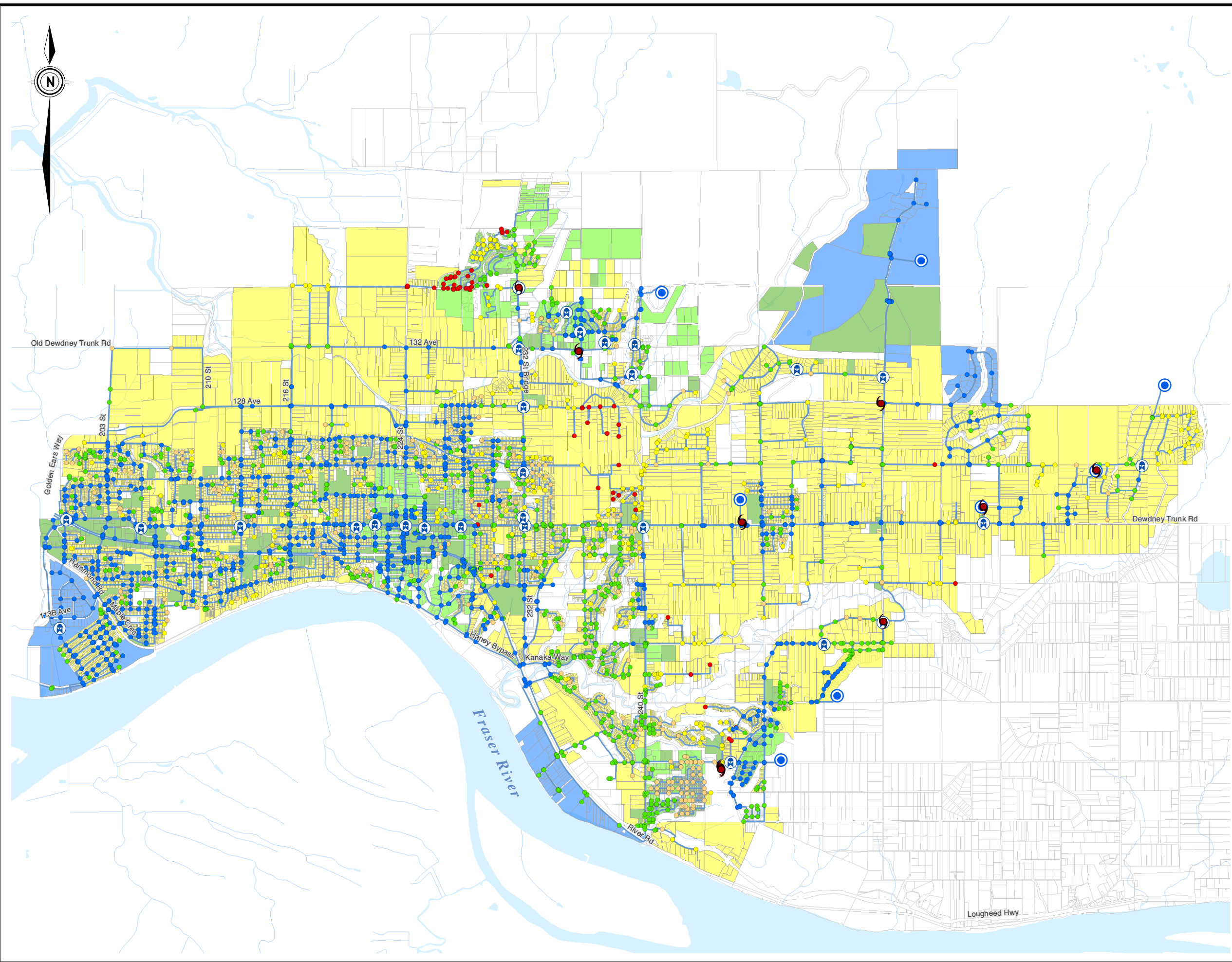

City of Maple Ridge Water Distribution Master Plan

Legend

- Water Main
- Existing Booster Pump Station
- Existing Reservoir
- Existing PRV

Available Fire Flow (L/s)

- 0 - 60
- 60 - 120
- 120 - 150
- 150 - 225
- > 225

Zoning Type / Required Fire Flow

- Single Family Residential (60 L/s)
- Multi-Family Residential (120 L/s)
- Commercial / Institutional (150 L/s)
- Industrial (225 L/s)

Criteria for Pressure at Required Fire Flow :
 Minimum residual pressure 150 kPa (22 psi)
 Minimum zone pressure 150 kPa (22 psi)

Notes: Available fire flow refers to model node results, which do not correspond directly with fire hydrant flows. Engineering judgement is required to identify fire flow deficiencies.

Available fire flow results demonstrate the effect of assumed growth rates should corresponding system upgrades not be implemented.



Copyright Notice: These materials are copyright of Kerr Wood Leidal Associates Ltd. (KWL). City of Maple Ridge is permitted to reproduce the materials for archiving and for distribution to third parties only as required to conduct business specifically relating to the Drinking Water Master Plan Update. Any other use of these materials without the written permission of KWL is prohibited.

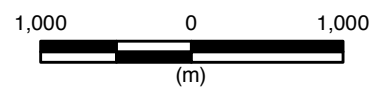





Project No. 173-164	Date November 2016
------------------------	-----------------------

Available Fire Flow Results 2023 System





Figure 10-7

City of Maple Ridge Water Distribution Master Plan







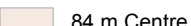
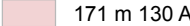
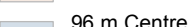
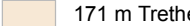
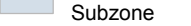
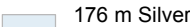

Legend

-  Water Main
-  Existing Booster Pump Station
-  Existing Reservoir
-  Existing PRV

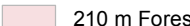
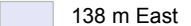
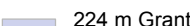
Peak Hour Pressure (psi)

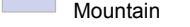
-  < 20
-  20 - 44
-  44 - 60
-  60 - 80
-  80 - 150
-  > 150

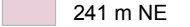
Pressure Zone

- | | | | |
|---|--------------------------|---|----------------------|
|  | 84 m Centre |  | 171 m 130 Ave |
|  | 96 m Centre Subzone |  | 171 m Tretheway |
|  | 122 m Fern |  | 176 m Silver Valley |
|  | 138 m East |  | 210 m Forest |
|  | 140 m Silver Valley West |  | 224 m Grant Mountain |
|  | 158 m Albion |  | 241 m NE |
|  | 158 m Lower Grant |  | 293 m Rothsay |
| | |  | 329 m Garibaldi |



Copyright Notice: These materials are copyright of Kerr Wood Leidal Associates Ltd. (KWL), City of Maple Ridge is permitted to reproduce the materials for archiving and for distribution to third parties only as required to conduct business specifically relating to the Drinking Water Master Plan Update. Any other use of these materials without the written permission of KWL is prohibited.

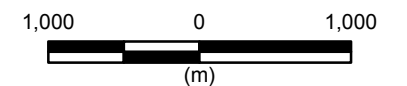

Project No. 173-164	Date June 2016
------------------------	-------------------

Peak Hour Demand Pressures 2041 System



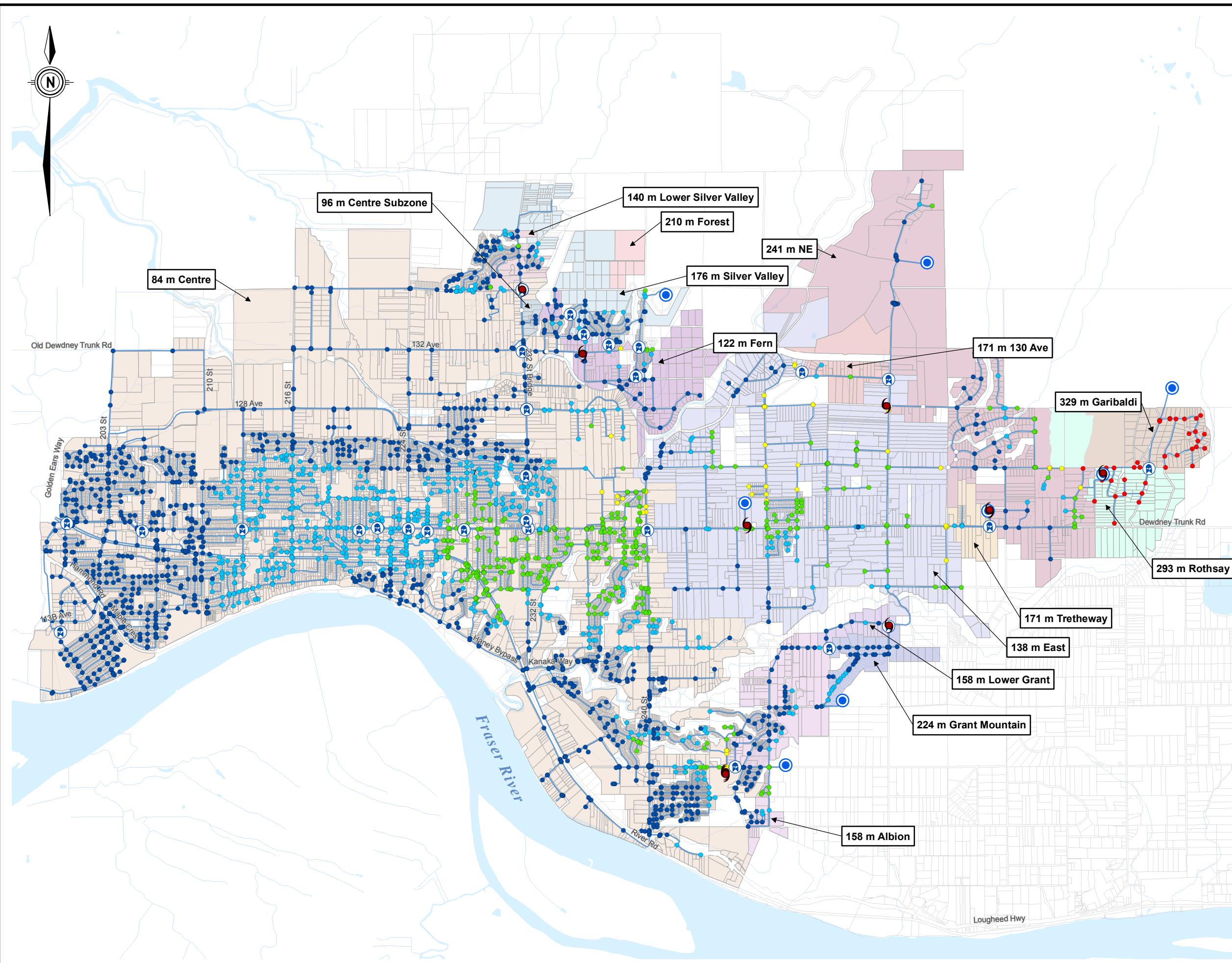









Figure 10-8



Path: C:\0100-0199\173-164\430-GIS\MXD-Rp173164_Figure10-8_PeakHourDemandPressure_2041\System.mxd Date Saved: 17/06/2016 2:36:15 PM Author: R.Taylor

City of Maple Ridge Water Distribution Master Plan

Legend

-  Water Main
 -  Existing Booster Pump Station
 -  Existing Reservoir
 -  Existing PRV
- Available Fire Flow (L/s)
-  0 - 60
 -  60 - 120
 -  120 - 150
 -  150 - 225
 -  > 225
- Zoning Type / Required Fire Flow
-  Single Family Residential (60 L/s)
 -  Multi-Family Residential (120 L/s)
 -  Commercial / Institutional (150 L/s)
 -  Industrial (225 L/s)

Criteria for Pressure at Required Fire Flow :
 Minimum residual pressure 150 kPa (22 psi)
 Minimum zone pressure 150 kPa (22 psi)

Notes: Available fire flow refers to model node results, which do not correspond directly with fire hydrant flows. Engineering judgement is required to identify fire flow deficiencies.

Available fire flow results demonstrate the effect of assumed growth rates should corresponding system upgrades not be implemented.



Copyright Notice: These materials are copyright of Kerr Wood Leidal Associates Ltd. (KWL). City of Maple Ridge is permitted to reproduce the materials for archiving and for distribution to third parties only as required to conduct business specifically relating to the Drinking Water Master Plan Update. Any other use of these materials without the written permission of KWL is prohibited.

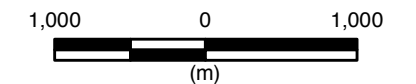

Project No. 173-164	Date November 2016
------------------------	-----------------------

Available Fire Flow Results 2041 System

Figure 10-9

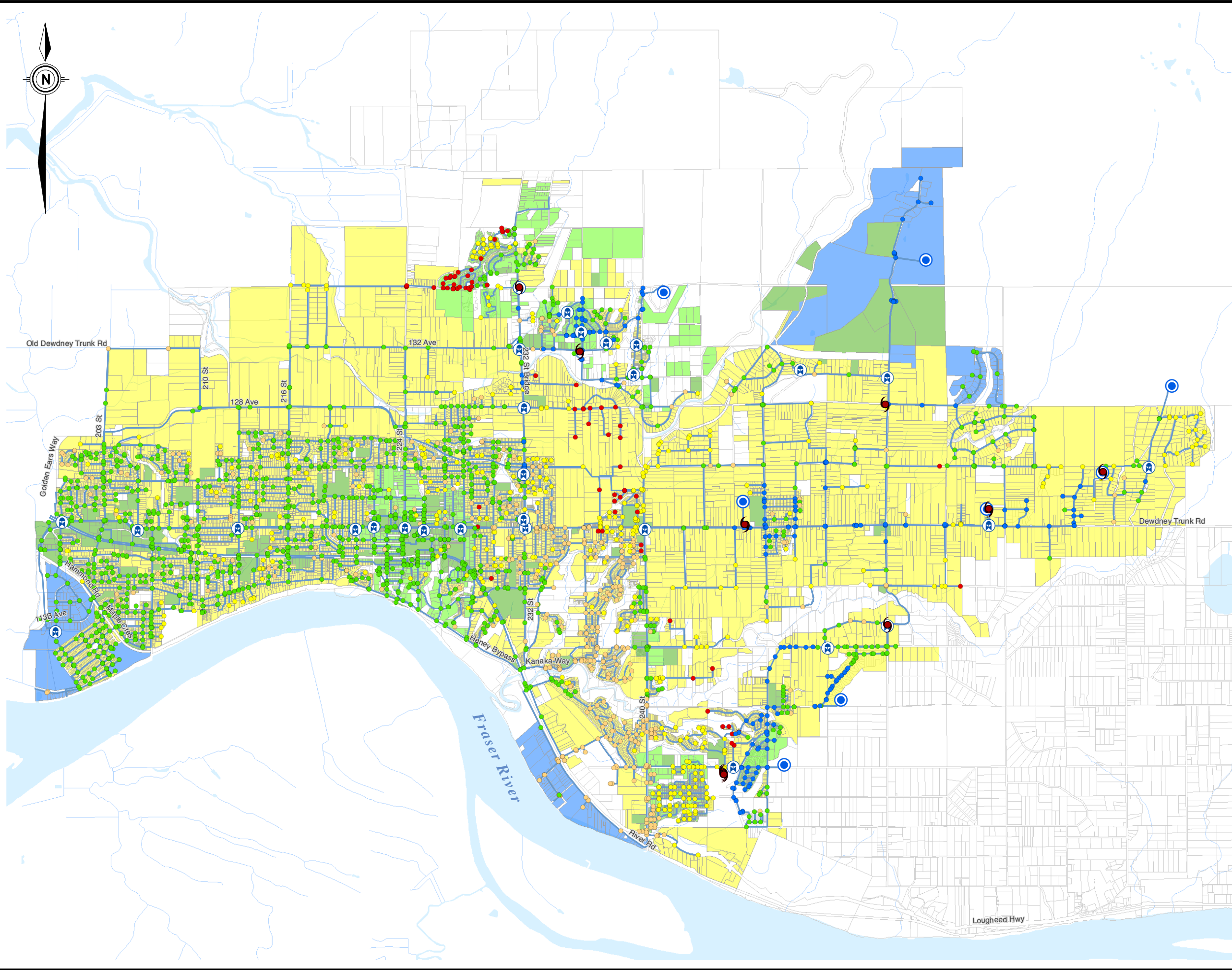



11. Water System Capital Projects

Proposed capital projects are summarized in the following sections. Locations for each of the identified projects to address short-term growth are presented on Figure 11-1; capital tasks to address future growth to 2041 are presented on Figure 11-2. Peak hour pressures and available fire flows for 2041 demands with the proposed upgrades in place are presented on Figure 11-3 and Figure 11-4. The list of projects has been organized by project type.

Tasks have been prioritized from 1 (highest priority) to 9 (lowest priority). Priority was set based on the area affected by the task and the relative cost (i.e., a low cost task which results in improvements to a large area will have a higher priority). Priorities are subjective and are meant to guide timing of projects only. Timing of other works (e.g., sewer and road upgrades), development needs, and other factors could change the ranking of the tasks. Future projects directly related to areas of new development have not been prioritized due to current uncertainty with regard to development timing.

A detailed summary of each capital project, organized by timeline and priority, is provided in Appendix G.

11.1 Reservoir Storage Projects

The capital tasks that have been identified to address reservoir storage are summarized in Table 11-1 below.

In some cases, an intermediate reservoir expansion has been recommended, with a further future expansion to final build-out volume. The staged approach has the benefit of allowing for the final reservoir size to be re-evaluated as development in the servicing area proceeds, allowing for the final phase to be increased or decreased as necessary.

It is noted that the final expansion of storage at a given site should consider the age and condition of existing infrastructure at the site. In some cases, it will potentially be beneficial for the final reservoir cell to be sized for the final demand growth interval as well as to replace the original reservoir.

Furthermore, locating future storage at an alternative site should be considered during the pre-design stage, as it may be beneficial for available fire flows, system redundancy, etc.



Table 11-1: Reservoir Projects

Name	Project Number (Addresses Note No.)	Timeline (Priority)	Existing Capacity	Proposed Capacity	Description
270A Street Storage Increase	2015-01 (S-04)	2018 (1)	0.6 ML	1.9 ML	Construction of a 1.3 ML reservoir at site of existing 270A reservoir is recommended to meet current balancing, fire, and emergency storage needs. It has been assumed that the new reservoir will be installed at the existing 270A Reservoir site; however, the optimal location for the new reservoir (as well as ultimate 2041 expansion of storage in the 241 m NE zone; Project 2015-35) should be determined through a siting study with City Operations input. Cost: \$1,800,000
McNutt Reservoir Expansion	2015-02 (S-07, H-08)	2018 (1)	0.633 ML	1.25 ML	Construction of a 1.00 ML reservoir is underway for the Garibaldi and Rothsay zones. Cost: \$900,000
Grant Mountain Reservoir Cell #2	2015-19 (S-03)	2018 (4)	0.765 ML	1.53 ML	The addition of a new 765 m ³ cell at the Grant Mountain reservoir site is recommended to address the Albion Zone's storage deficit. The existing reservoir site layout includes space and connections for a second cell. Cost: \$1,100,000
241 m NE Zone Reservoir Expansion	2015-35 (S-04)	2041	1.9 ML (2015-01 Complete)	3.2 ML	This project consists of installing the final 1,300 m ³ of storage capacity for 241 m NE Zone. It is recommended to address future balancing and fire protection needs for the 241 NE zone and Garibaldi zone. The reservoir could be installed at existing 270A site or at a different location. Cost: \$1,800,000



11.2 Pump Station Projects

The capital tasks that have been identified to address pumping are summarized in Table 11-2 below.

Table 11-2: Pump Station Projects

Name	Project Number (Addresses Note No.)	Timeline (Priority)	Existing Capacity	Proposed Installed Power	Description
270A Pump Station Upgrade	2015-13 (P-02)	2018 (3)	80 hp	120 hp	Preliminary pump sizing indicates 2 x 60 hp (includes one standby), with room for a third future pump. This item is recommended to meet the future demands of the 293 m Rothsay and 329 m Garibaldi zones as a result of Maple Benchlands development. Cost: \$120,000
Upgrade 236 Street Pump Station	2015-25 (P-03)	2041	200 hp	240 hp	To meet future demands in the 176 m Rockridge and 176 m Silver Valley West Zone it is recommended that the capacity of 236 Street Pump Station be increased to 80 L/s @ 106 m TDH. An alternative option would be to directly pump into lower zones rather than through the Rockridge Reservoir, by upgrading the 232 Street Pump Station to provide domestic <u>and</u> fire flows to the 140 m Lower Silver Valley Zone. Cost: \$260,000
263 Street Pump Station Replacement	2015-33 (P-01)	2041	150 hp	300 hp	This project involves the replacement of the existing 263 Street Pump Station. The preliminary installed power for the new station is 300 hp. This is based on the 256 Street and 263 Street pump station working in conjunction, with one pump out of service between the two stations. For additional details of a previous assessment of the existing 263 Street Pump Station, refer to KWL file 173.135. Cost: \$2,500,000
270A Pump Station Replacement	2015-51 (P-02)	2041	80 hp	210 hp	Project No. 2015-13 includes replacing the existing 270A pump station with new above ground building (tentatively 210 hp, includes one standby). Cost: \$1,500,000



11.3 Linear Infrastructure and PRV Projects

The capital tasks that have been identified to improve hydraulic performance are presented in Table 11-3 below.

Table 11-3: Linear Infrastructure and PRV projects

Name	Project Number (Addresses Note No.)	Timeline (Priority)	Description
112 Avenue Loop to 110 Avenue	2015-14 (H-25)	2018 (4)	To improve fire flows, reliability and water quality to 110 and 112 Avenue east of 240 Street, looping of the dead end water mains is recommended. The project includes installation of 330 m of 150 mm diameter Ductile Iron main on 112th Avenue to Cameron Court east of 240 Street. A right-of-way is required through private property between 110 Avenue and 112 Avenue. A creek crossing would be required. Cost: \$140,000
Looping Between 238 Street and 239 Street	2015-15 (H-01, H-27)	2018 (4)	This project would improve available fire flow and peak hour pressure on 238 th and 239 th Streets. The project involves installation roughly 210 m of 150 mm dia. water main and includes a creek crossing. Cost: \$150,000
260 Street Water Main Upgrade	2015-16 (H-33)	2018 (4)	This project involves replacing (and upsizing) the existing AC main on 260 Street in order to improve available fire flow at the south end of 260 Street. Cost: \$200,000
241A Street Water Main Looping	2015-18 (H-24)	2018 (4)	This project would improve available fire flow on 241A Street. It involves the construction of approximately 350 m of 200 mm dia. water main and would entail acquiring a new SROW at north end of 241A Street. The water main ends at boundary between 138 m east and 241 m NE zones. There are limited options for looping and connections to 240A Street are not accessible due to the positioning of existing homes. Other constraints include a creek to the south of 241 Street. Feasibility should be confirmed as part of a servicing review. Cost: \$160,000
Fisherman Road Looping	2015-23 (H-34)	2018 (5)	Project No. 2015-23 would include upsizing approximately 450 m of existing 200 mm dia. main on Fisherman Road to 250 mm diameter. This will improve available fire flow at existing industrial developments on Fisherman Road. This item should be considered as a DCC project or included as required scope for adjacent land development. Cost: \$225,000
124 Avenue Water Main Looping	2015-24 (H-32)	2018 (5)	This project is recommended to improve available fire flow on 124 Avenue. It would include the installation of approximately 800 m of 200 mm diameter pipe along the 260 Street alignment from 124 Avenue to Dewdney Trunk Road where the water main would terminate at the boundary between 138 m East and 241 m NE zones. Feasibility should be confirmed, possibly as part of a servicing review. Cost: \$360,000



Name	Project Number (Addresses Note No.)	Timeline (Priority)	Description
PRV-240 Upgrade	2015-06 (H-09, H-50)	2018 (3)	<p>The existing PRV at 240 Street and Dewdney Trunk Road is creating hydraulic losses in excess of 3 m HGL are experienced at peak hour demands (refer to field testing results in Appendix C). Replacing PRV-240 with a larger PRV and upsizing the connection piping would improve overall PHD pressures to the southern portions of the 84 m Centre zone.</p> <p>Project 2015-06 is to construct a 100 mm diameter low flow PRV to the downstream 500 mm diameter transmission main and replace the existing 300 mm dia. PRV with a new 400 mm dia. PRV in the existing chamber.</p> <p>Cost: \$200,000</p>
104 Avenue - Slatford Place to 240 Street	2015-46	2041	<p>As identified in KWL's River Road Seismic Assessment (173.131) this project would replace 170 m of 200 mm dia. main with 250 mm diameter and is recommended for proper servicing of the Albion Flats area.</p> <p>Cost: \$100,000</p>
128 Avenue to Dogwood Avenue Looping	2015-50 (H-27)	2041	<p>Under this task 410 m of 200 mm diameter from Dogwood Avenue to 128 Crescent would be installed. This would improve fire flow protection locally and looping would improve water quality and reliability for both Dogwood Avenue and 128 Avenue areas. Future projections also show that fire flows at east end of 128 Avenue and to south may be marginal in future and would be addressed under this task. Note, a water quality assessment may increase the priority of this project.</p> <p>Cost: \$200,000</p>
245B Street PRV Setting	2015-17 (H-03, H-26)	2018 (4)	<p>The scope of this project involves adjusting the 150 mm diameter PRV set point to 115 m HGL (note, 50 mm dia. PRV set point assumed to be kept 10 psi higher). This will improve available fire flow at north end of 245B Street.</p> <p>Cost: Nominal</p>
Wharf Street Upsizing	2015-62 (H-28, H-47)	2041	<p>This project would include construction of approximately 460 m of 300 mm water main to replace the existing 200 mm main on Wharf Street. Replacement main to be installed starting at Hazelwood Street to west end of Wharf Street. Improves available fire flows at the west end of Wharf Street.</p> <p>This project is dependent on development, and should be re-assessed when development plans are available. Looping through northern industrial parcels could also be considered; project to be confirmed with a servicing review.</p> <p>Cost: \$270,000</p>



Name	Project Number (Addresses Note No.)	Timeline (Priority)	Description
Backflow Prevention – Top of Garibaldi Zone	2015-20	2018 (5)	Backflow prevention is proposed for several lots – estimated 10 services total - at localized high points on 128 Avenue where house elevation exceeds 295m in the 329 m Garibaldi pressure zone. These locations have a higher risk of cross-connection backflow during high demand periods (i.e., fire flows). Future considerations should be made to determine the effect of pressure loss through backflow preventers to these lots. Where backflow prevention has been recommended, the 150 kPa minimum zone pressure requirement has been waived. Cost: \$20,000

High static pressures have been noted in a several locations. The highest static pressures calculated in the model are around 160 psi. It is noted that until recently, the City’s Design Criteria manual allowed for maximum pressures of 150 psi. As these high static pressures are within 10 psi of the maximum allowable design pressure at the time these areas were developed, no capital projects have been recommended to address the marginally high pressures. In all cases, a new PRV station would be required in order to create a subzone, which would typically result in the elimination of existing water main loops within the greater zone. This could lead to water quality issues, and therefore capital projects are not recommended.

11.4 Upgrades to Increase Redundancy

The capital tasks that have been identified to increase redundancy are summarized in Table 11-4 below. Note that these projects improve system performance and reliability, but are not required to meet fire flow or pressure criteria. The projects may be completed at the City’s discretion.

Table 11-4: Upgrades to Increase Redundancy

Name	Project Number (Addresses Note No.)	Timeline (Priority)	Description
McNutt Road to Garibaldi Street Looping	2015-27 (R-01)	2041	Project No. 2015-27 involves the construction of approximately 220 m of 200 mm DI water main connecting the McNutt Road Supply main to Garibaldi Street along the 124 Avenue ROW. This will allow for the entire zone to meet fire flow requirements during MDD in combination with improving service for future developments. The upgrade will also improve water circulation throughout the zone. Fire flows are expected to improve from roughly 60 L/s to >120 L/s to meet multi-family residential requirements. However, the area is zoned for single family residential, therefore >60 L/s not required. Cost: \$110,000



Name	Project Number (Addresses Note No.)	Timeline (Priority)	Description
256 Street Water Main Upgrades	2015-29 (R-04)	2041	Project would involve twinning the existing water main on 256 Street, north of DTR to 256 Street Pump Station with 1,600 m of 300 mm dia. DI water main. This would result in improved flow rate and supply reliability to 256 Street Pump Station and downstream zones which would help accommodate future demands. Not required to meet specific fire flow or peak hour pressure concern but would improve overall redundancy in the area. Cost: \$910,000
269 Street and 270 Street Water Main Upgrades	2015-30 (R-05)	2041	Similar to above, this infrastructure upgrade would twin the existing water main on 269 Street and 270 Street, north of DTR to the 270A Reservoir, with 1,010 m of 300 mm diameter DI water main as a dedicated transmission line. This would result in improved flow rate and supply reliability to 270A Street Reservoir, help to address future demands and improve overall redundancy in the area. Cost: \$575,000
270A Pump Station to McNutt Road Water Main Upgrades	2015-31 (R-02)	2041	This capital project consists of twinning the existing water main between 270A Pump Station to McNutt Road, with 660 m of 300 mm diameter DI water main. It would allow for improved flow rates and supply reliability to Garibaldi and Rothsay pressure zones as well as helping to meet future demands and improve redundancy in the affected zones. Cost: \$380,000
108 Avenue Transmission, Grant to Albion Zone PRV	2015-04 (R-03)	Completed 2016	This project includes constructing 350 m of new 300 mm diameter DI water main connecting the Grant Mountain Reservoir to the Albion Zone PRV Station. It will include the installation of the 108 Avenue Albion Zone PRV. Completion will allow for the Grant Mountain Reservoir to provide back-up fire protection to the Albion Zone and count towards this zones fire flow storage requirements.
112 Avenue Transmission, Albion Zone PRV to 248 Street	2015-32 (R-03)	2041	Project No. 2015-32 involves the construction of 360 m of new 300 mm diameter DI water main connecting the Albion Zone PRV Station from Grant Mountain to the Albion distribution system at 248 Street. This would allow for the Grant Mountain Reservoir to provide back-up fire protection to the Albion Zone. Cost: \$215,000



11.5 Miscellaneous Water System Improvements

The capital task summarized in Table 11-5 below addresses a miscellaneous item identified during the study. This water system improvement may be undertaken at the City’s discretion.

Table 11-5: Miscellaneous Water System Improvement

Name	Project Number (Addresses Note No.)	Timeline (Priority)	Description
River Road Seismic Event Automatic Isolation Valves	2015-22 (O-02)	2018 (5)	<p>In a seismic event, vulnerable sections of the River Road are subject to soil liquefaction, which could cause significant damage to the local water mains. In order to isolate the effects of this damage from the rest of the water system, isolation valves were recommended by the River Road Seismic Assessment Report. The valves would automatically close in the event of seismic activity followed by loss of system pressure.¹³ Project No. 2015-22 is to construct three valve chambers at:</p> <ul style="list-style-type: none"> • Lougheed Highway and Haney Bypass; • Tamarack Lane and Lougheed Hwy; and • 240 Street and Lougheed Hwy. <p>Cost: \$1,000,000</p>

11.6 Silver Valley Servicing

The Silver Valley area is expected to continue to be one of the fastest growing areas of the city. Many of the most recent subdivision applications have been for properties in Silver Valley. This section summarizes the findings of the previous water servicing reviews for this area and provides an update in light of the findings of this master plan.

Previous Reports and Technical Memoranda

Previous work concerning the servicing of the Silver Valley area includes:

1. “Silver Valley Water Zoning Options”, KWL technical memorandum, April 16, 2003 (KWL file 173.012).
2. “Silver Maples Water Servicing Update”; KWL report, April 2005 (KWL file 2041.018).
3. “Rockridge Reservoir Expansion Needs Assessment”, KWL technical memorandum, October 22, 2013 (KWL file 173.150).
4. “Campton Development Water Servicing Review”, KWL technical memorandum, May 2, 2014 (KWL file 173.158).
5. “13300 - 240 Street Strata Lot Servicing”, KWL technical memorandum, January 9, 2014 (KWL file 173.152).
6. “Silver Valley Reservoir Siting”, KWL report, February 2015 (KWL file 173.161).

¹³ KWL Project 173.131.



7. "Nelson Peaks Development Water Servicing Review", KWL technical memorandum, October 10, 2014 (KWL file 2375.018).
8. "Birdtail Subdivision – Pressure Zone Servicing Review", KWL technical memorandum, April 30, 2015 (KWL file 173.171).
9. "23771/23753 130th Avenue Development Water Servicing Study", KWL technical memorandum, June 17, 2015 (KWL file 173.174).

Current Plan

The Silver Valley water servicing area is shown on Figure 11-1 and Figure 11-2. The most significant changes proposed for the Silver Valley area are related to the conversion of the existing 96 m HGL feeder main on 232 St. to 176 m HGL, for the pipe section north of 136 Avenue (Project 2015-10). This will allow for development at higher elevations on Silver Valley Road and Marc Road.

Currently the 96 m HGL feeder main provides flow up 232 Street to Foreman Drive. The 96 m HGL is necessary in order to ensure adequate minimum pressure at 232 Street and Silver Valley Road (a localized high point on the feeder main). However, once this main is converted to 176 m HGL, this high point will no longer govern the main pressure and the distribution mains currently being fed 96 m HGL can revert to 84 m HGL. Completing the connection to the 84 m Centre Zone (Project 2015-08) on the west side of Silver Valley will negate the need to supply via Foreman Drive. The connection between the 176 m HGL main and the distribution main on Foreman will require pressure reduction via a PRV station (Project 2015-11). This connection would be for fire flow or emergencies only, as reducing from 176 m HGL to 84 m HGL is not energy efficient for normal supply.

To provide a redundant connection to the 84 m HGL area of Silver Valley, a new PRV station is proposed at the intersection of 232 Street and 136 Avenue (Project 2015-26). This will allow for the 96 m HGL MV supply to feed Silver Valley. Further, maintaining the 96 m HGL to supply the 232 Street and 236 Street pump stations is beneficial from an energy efficiency perspective as the suction head is maintained (rather than decreased if the 96 m HGL main was eliminated entirely).

Conversion of the distribution area of Silver Valley to the 84 m Centre Zone has the benefit of eliminating the exposure of the distribution mains to the un-regulated MV supply (which could potentially be subject to pressure spikes).

The highest ground elevations in the Silver Valley area cannot be adequately serviced by the existing 176 m HGL zone. If development proceeds in this area, a new booster pump station will be required to feed the future 210 m Forest Zone (Project 2015-37). It is anticipated that the zone demand will be low, and that supply will be pumped, rather than gravity fed from a new reservoir. Refer to Figure 11-3 for the approximate location of the future Forest Zone.

Parcels north of 136 Avenue, including an institutional parcel, will require a new transmission main for servicing. The new main would likely be installed along the 136 Avenue ROW between 240 Street and 236 Street (Project 2015-36). This main will provide a backbone for servicing the area, with a direct connection to the Rockridge Reservoir supply main to maximize available fire flows.

The proposed projects related to the Silver Valley area are summarized in Table 11-6.



Table 11-6: Upgrades within the Silver Valley Area

Name	Project Number (Addresses Note No.)	Timeline (Priority)	Description
Silver Valley Reservoir Expansion	2015-47 (S-02)	N/A	This storage expansion project has been completed and is operational as of 2016.
136 Avenue Silver Maples Low Pressure Distribution Main Looping – 232 Street Connection	2015-07 (H-29)	2018 (3)	This project involves the construction of roughly 220 m of 250 mm diameter water main to complete looping of existing piping on 136 Avenue between 232 Street and Silver Maples. This will improve fire flows to Silver Maples and improve supply redundancy. Note that this task is developer driven, and is currently part of the Campton Development servicing plan (KWL file 173.158). This task is also related to Project No. 2015-08. Cost: \$125,000
136 Avenue Silver Maples Low Pressure Distribution Main Looping – 224 Street Connection	2015-08 (H-30)	2018 (3)	This project will include installation of approximately 450 m of 200 mm dia. water main between 224 St. and Silver Maples (Foreman Dr.) on 136 Avenue. The project will complete a direct connection between the 84 m Centre Zone and the proposed 84 m HGL portion of Silver Valley (currently 96 m Centre Subzone). Cost: \$210,000
Extension of the 176 m HGL Zone to Northwest Silver Valley Area	2015-10	2018 (3)	Project No. 2015-10 will involve converting the existing 300 mm diameter DI water main on Marc Rd. from 96 m HGL to 176 m HGL. This will necessitate the installation of a new PRV at Foreman Drive. The purpose is to allow for development at higher elevations in northwest Silver Valley. Conversion of the main can occur at any time and assumes construction of a short connection between existing mains at 136 Avenue, in order to disconnect from the 96 m Zone. Completion of Foreman Drive PRV chamber is required prior to pressure change (refer to Project 2015-11). Because this is an existing main, it should be verified that it has been designed and pressure tested for operation at 176 m HGL and that any branch and service connections are also designed for this pressure. Cost: \$20,000
Marc Rd. Water Main Extension	2015-12	2018 (3)	This project involves the construction of approximately 200 m of 300 mm diameter water main on Marc Rd. to 141 Avenue. This will allow for initial redevelopment along the northern portion of Marc Rd. Ultimately, mains on Marc Rd. and Silver Valley Rd. are intended to connect via 141 Avenue. The City should consider further extension on Marc Rd. and along 141 Avenue as developer driven. In the longer term this project's completion will also be useful for looping from the 176 m pressure zone to the 140 m Lower Silver Valley Zone (along Silver Valley Road). Cost: \$115,000



Name	Project Number (Addresses Note No.)	Timeline (Priority)	Description
Foreman Drive PRV Station	2015-11	2018 (3)	Construction of a new 150 mm PRV Station on Foreman Drive at 232 Avenue is required to provide additional fire flow and an emergency connection from 176 m Rockridge pressure zone to the proposed 84 m Centre zone in Silver Valley. The buried chamber is already installed; installation of internal piping/valves is required to complete the station. Cost: \$75,000
232 Street PRV Station	2015-26	2018 (3)	Installation of a PRV station at or near the intersection of 232 Street and 136 Avenue (near existing 232 Street Pump Station), connecting the 96 m Centre Subzone to the 84 m Centre Zone. Project is contingent on conversion of the 96 m HGL area of Silver Valley to the 84 m Centre Zone. Cost: \$200,000
Forest Pump Station	2015-37	2041	Construction of a new 90 HP pump station (2 x 10 HP duty pumps + 75 HP fire pump) to supply new Forest Zone falls under Project No. 2015-37. The Forest Zone is anticipated to be the last area of Silver Valley to be developed. Cost: \$1,000,000
136 Avenue Rockridge Zone Looping	2015-36	2041	This item involves the construction of 1050 m of new 200 mm diameter water main connecting 236 Street and 240 Street ROW via 136 Avenue. This upgrade would serve to extend the serviced region of the system while improving water quality and reliability in Rockridge zone. This project is driven by development north of 136 Avenue between 236 Street and 240 Street. The proposed main would be the backbone for fire flow supply, especially to the institutional parcel north of 136 Avenue. Cost: \$500,000

It is understood that there is a greater push for development to begin on Silver Valley Road prior to Marc Road. The current developments on Silver Valley Road that are serviced by the Maple Ridge water system are part of the 140 m Lower Silver Valley zone. This zone can service up to 100 m elevation, which is generally where the current development on Silver Valley Road ends.

Increasing the pressure in the 140 m Lower Silver Valley Zone to allow for development at higher elevations is not feasible, as the static pressures at the properties with the lowest elevations would increase beyond 150 psi. If development proceeds such that parcels are developed on Silver Valley Road prior to Marc Road, a parallel main on Silver Valley Road from 232 Street carrying 176 m pressure would be required.

Ultimately, it is anticipated that the main on Marc Road will be connected to Silver Valley Road via 141 Avenue, along with a PRV on Silver Valley Road to separate the 176 m and 140 m pressure zones. These potential future projects are shown on Figure 11-2.



11.7 Thornhill Urban Reserve Servicing

The Thornhill area is a potentially significant development in the southeast portion of the city, roughly between 248 Street and 272 Street on the west and east sides respectively, and bounded by Grant Mountain to the north, and 100 Avenue to the south. The Thornhill Urban Reserve boundary is shown on Figure 11-2.

Prior to urban development occurring in Thornhill, an area plan is to be developed that will specify land use patterns, density, and servicing requirements. While the future population of Thornhill is unknown at this time, the buildout MDD for the area has been estimated as 131 L/s. This demand is based on a population of 19,429 identified in the City's outdated 1996 OCP (the current OCP does not specify a future population), and was derived as described below.

Demand Estimate

KWL has updated the estimated future demand for the proposed Thornhill Urban Reserve based on the following assumptions:

1. A design population of 19,429 per the CMR 1996 OCP;
2. A base demand unit rate of 250 L/ca/day per current WMP;
3. A total irrigable area of 1,062 ha; and
4. A seasonal demand unit rate of 0.47 L/s/ha per current WMP.

To establish irrigable area, KWL used the following assumptions:

1. Slopes greater than 25% cannot be developed;
2. Area within a 20 m buffer of existing creeks will not be developed;
3. Lots greater than 2 ha were given a 20% allowance for roads, assuming they will be subdivided into smaller lots;
4. Parcels greater than 0.8 ha will be subdivided into parcels no larger than 0.4 ha; and
5. Irrigable area was assigned to the remaining developable areas per assumptions outlined in Section 5.4.

Historical Servicing Strategy

Conveying MDD flow from the MV transmission main on Dewdney Trunk Rd. to the Thornhill area will require significant upgrades to the existing transmission/distribution systems and pumping/storage capacities.

Given Thornhill's geographic location, the possible servicing of this area must be a consideration in any future upgrades to the 240 Street transmission system. The significant flow demand for Thornhill will affect the sizing of a new 240 Street transmission main, as long as 240 Street continues to be the primary feed to the south.

A conceptual plan for servicing the Thornhill area was presented in the memorandum *Thornhill Conceptual Water Servicing Strategy*, prepared by Urban Systems (File 1279.0015.01; May 27, 2014).

Urban Systems' proposed servicing strategy for Thornhill is to construct a new pump station at the 246 Street Reservoir Site and convey water to a new reservoir in Thornhill via a dedicated supply main in the 240 Street corridor.



Revised Servicing Strategy

The following section provides an updated servicing strategy in light of the findings of this master plan. It should be noted that the objective of this review is to determine capital upgrade requirements to convey water to the Thornhill area. A more detailed study will be required to determine the capital upgrades required for servicing within Thornhill (e.g., zone boundaries, higher elevation pump stations and reservoirs).

It is proposed that the Thornhill area be serviced via a new transmission main (refer to Figure 11-2) that would convey 96 m HGL pressure (i.e., a non-pressure-regulated MV connection) from Dewdney Trunk Road to 104 Avenue. The transmission main would continue east on 104 Avenue to the location of a new Thornhill Pump Station, which would then pump to a reservoir at an appropriate elevation in the Thornhill area.

Extending the 96 m HGL toward the south end of 240 Street would have the following additional benefits:

1. The Albion Pump Station could be connected to the new 96 m HGL main, improving suction head conditions, as well as offsetting the Albion demands from the existing 84 m HGL transmission main on 240 Street; and
2. The southeast portions of the 84 m Zone could ultimately be connected to a new PRV station located near the south end of 240 Street, which would improve peak hour pressures in the area and also reduce the peak flows in the existing 240 Street transmission main (and at the 240 Street PRV Station).

Serviced Elevations

The existing ground elevations within the Thornhill Urban Reserve boundary range from roughly 100 m to 310 m GD. As such, several pressure zones would be required to service the area.

For the purpose of the master plan, a new Thornhill Pump Station has been assumed to supply MDD to a primary Thornhill Reservoir (Reservoir No. 1) with a TWL of 220 m. This elevation represents a TWL that would be capable of servicing roughly the bottom third of the range of ground elevations in the Thornhill area. A reduced-pressure zone, with a maximum design HGL of roughly 190 m will be required for the lowest ground elevations in the Thornhill area.

A secondary pump station would then convey water between Reservoir No. 1 and a proposed secondary reservoir (Reservoir No. 2) near the uppermost elevation in the Thornhill area. The pump station would be capable of providing the MDD for the remainder of Thornhill above the servicing elevation of Reservoir No. 1.

Conceptually, Thornhill Reservoir No. 2 will have a TWL of 330 m. The reservoir would supply the uppermost Thornhill area, as well as a series of stepped pressure zones.

Once an area plan is completed for Thornhill, a detailed study should be completed to determine optimal elevations and number of reservoirs, as well as pressure zone boundaries.

The preliminary projects identified for Thornhill servicing area summarized in Table 11-7 below. These projects are specific to Thornhill servicing, and are independent of servicing the existing population.



Table 11-7: Capital Projects for Conveying Water to Thornhill

Name	Project Number	Timeline (Priority)	Description
Thornhill Supply Main	2015-44	Depends on Development Timing (9)	This project would include the installation of approximately 4,300 m of new 400 mm dia. transmission main on 240 Street and 104 Avenue, from DTR to approximately 245B Street (general area of the existing Albion Pump Station). The upgrade would provide MDD flows to Thornhill, as well as the Albion Zone. Note that consideration should be given to upsizing this main in order to service Albion Flats and/or Kwantlen First Nation. See note following this table. Cost: \$2,700,000
Thornhill Pump Station	2015-45	Depends on Development Timing (9)	Project involves the construction of a new pump station to provide MDD flows to the future Thornhill Urban Reserve (buildout MDD = 131 L/s). Conceptually, pump station to be located near existing Albion PS (consideration should be given to expanding the Albion station to provide Albion and Thornhill supply). Preliminary total installed sizing 600 hp. Cost: \$4,100,000
Thornhill Reservoir No. 1 Supply Main	2015-52	Depends on Development Timing (9)	This project would include the construction of approximately 1,400 m of new 400 mm dia. transmission main between the proposed Thornhill Pump Station and the future Thornhill Reservoir No. 1. The pipe length is preliminary, and assumes the pump station is near the existing Albion pump station and the reservoir is at approximately elevation 220 m GD. Cost: \$940,000
Thornhill Reservoir No. 1	2015-53	Depends on Development Timing (9)	This project will be required if development of the Thornhill Urban Reserve moves forward. The recommended size is based on an MDD of 55 L/s, and a required fire flow of 150 L/s (institutional/commercial). Reservoir siting study required for predesign. Cost: \$2,500,000
Thornhill Secondary Pump Station	2015-54	Depends on Development Timing (9)	Construct a new 300 hp pump station to supply the upper Thornhill servicing area, by filling future Thornhill Reservoir #2. Preliminary design flow for station is 76 L/s. Cost: \$2,100,000
Thornhill Reservoir No. 2 Supply Main	2015-55	Depends on Development Timing (9)	Construct approximately 1,800 m of 300 mm dia. water main between the proposed Thornhill Secondary Pump Station and Thornhill Reservoir #2. Cost: \$1,020,000
Thornhill Reservoir No. 2	2015-56	Depends on Development Timing (9)	Construct approximately 3.41 ML of storage at elevation 330 m. Required to provide balancing, fire, and emergency storage for the serviced area of the Thornhill Urban Reserve above approximately elevation 180 m. The recommended size is based on 76 L/s MDD. Cost: \$3,000,000
Thornhill On-Site PRV Stations	2015-57	Depends on Development Timing (9)	Construction of four PRV stations, to supply intermediate pressure zones below proposed Thornhill Reservoir No. 2 and above the servicing elevation of proposed Thornhill Reservoir No. 1. Further, two additional PRVs are required to service the lowest elevations within the Reservoir #1 service area. Assumes six stations total (i.e., redundant PRV connections to each pressure zone). Cost: \$1,200,000



Project 2015-44 is a common element to servicing Thornhill and for potential servicing of Albion Flats densification Kwantlen First Nation development. These latter two areas are not approved as part of the OCP, therefore the capital cost opinion for Project 2015-44 is based on sizing without flow to these areas. If either one or both of these areas are serviced in addition to Thornhill, a 450 mm dia. main is recommended, at an upsizing cost of approximately \$350,000 (\$3,050,000 total).

11.8 Albion Flats Densification

The possible Albion Flats Densification area is shown on Figure 11-2.¹⁴ The densification of the area would add an estimated 36 L/s MDD to the southeast 84 m Centre Zone (for reference, Thornhill MDD is estimated at 131 L/s). If this development moves forward in addition to Thornhill, it is recommended that the proposed 96 m HGL transmission main on 240 Street be sized to convey the additional 36 L/s and that a new PRV station be installed at 240 Street and 104 Avenue, in order to link the proposed transmission main to the southern portion of the 84 m Centre Zone. In this case, the size of the proposed 96 m transmission main would be increased from 400 mm dia. to 450 mm dia. The upsizing cost is approximately \$350,000 (\$3,050,000 total). If densification moves forward before Thornhill, it is recommended that a portion of the 96 m HGL transmission main be built on 240 St at 450 mm dia. Concept level population estimates have been used in this analysis – a future servicing review is recommended if Albion Flats densification is approved to confirm sizing and length of the transmission main upgrade.

For local servicing within Albion Flats, construction of a 300 mm dia. water main between Tamarack Lane and 240 Street, roughly parallel to River Road, has previously been proposed as part of the Albion Flats Water Servicing Study (KWL File 173.128).

The capital projects related to servicing the Albion Flats area are summarized in Table 11-8 below. Note that when planning any major upgrades in the 240 Street corridor, it is recommended that the potential servicing of Thornhill and/or KFN be considered when sizing infrastructure.

Table 11-8: Capital Projects for Albion Flats Servicing

Name	Project Number	Timeline (Priority)	Description
240 St. and 104 Ave. PRV Station	2015-58	Depends on Development Timing (9)	Construction of a PRV station at the south end of the proposed 96 m HGL transmission main on 240 Street. Addition of a PRV station will offset demands from the existing 84 m HGL transmission main on 240 Street, and improve flows to the proposed Albion Flats area. Cost: \$200,000
Albion Flats Water Main	2015-59	Depends on Development Timing (9)	Construction of approximately 2,400 m of 300 mm dia. water main between Tamarack Lane and 240 Street. Proposed main forms a backbone through the proposed Albion Flats area. Cost: \$1,360,000
240 Street Transmission Main	N/A	Depends on Development Timing (9)	Consider upsizing/twinning a portion of the 240 Street transmission main to accommodate increased demands due to Albion Flats, if servicing occurs independently of Thornhill. The upsizing cost is approximately \$350,000 (\$3,050,000 total).

¹⁴ The Albion Flats Densification area is subject to change. Future studies will update the boundaries and demands.



11.9 Kwantlen First Nation

The potential servicing of the Kwantlen First Nation is also related to the potential Thornhill servicing upgrades. The Kwantlen buildout MDD has been estimated to be 43 L/s (for reference, Thornhill MDD is estimated at 131 L/s).

KWL has previously recommended that the Kwantlen system be connected to the 158 m Albion Zone. The additional demands would necessitate an upgrade to the existing Albion pump station. It has been assumed that balancing, fire, and emergency storage would be provided by a reservoir located on the Kwantlen First Nation Reserve (not included in capital projects).

Similar to the Albion Flats Densification, connecting the Kwantlen First Nation to the City's water system has been considered in conjunction with Thornhill servicing since they are in close proximity. The proposed 96 m HGL transmission main would again be upsized from 400 mm dia. to 450 mm dia. if Kwantlen is added to the Thornhill demand. The upsizing cost is approximately \$350,000 (\$3,050,000 total). If KFN development moves forward before Thornhill, it is recommended that a portion of the 96 m HGL transmission main be built on 240 St at 450 mm dia. Concept level population estimates have been used in this analysis – a future servicing review is recommended if KFN development is approved to confirm sizing and length of the transmission main upgrade.

The capital projects related to servicing the Kwantlen First Nation are summarized in Table 11-9 below.

Table 11-9: Upgrades Required for Kwantlen First Nation Servicing

Name	Project Number	Timeline (Priority)	Description
KFN Feeder Main	2015-60	Depends on Development Timing (9)	Construction of approximately 75 m of 250 mm dia. water main on 248 Street between 100 Avenue and the KFN boundary. Cost: \$50,000
Albion Pump Stn Capacity Increase for KFN	2015-61	Depends on Development Timing (9)	Increase the firm capacity of the existing Albion Pump Station by 43 L/s. The capacity increase will account for the estimated MDD demand for KFN. Cost: \$450,000
240 Street Transmission Main	N/A	Depends on Development Timing (9)	Consider upsizing/twinning a portion of the 240 Street transmission main to accommodate increased demands due to Kwantlen First Nation, if servicing occurs independently of Thornhill. The upsizing cost is approximately \$350,000 (\$3,050,000 total).



11.10 Possible OCP Densification

As described in Section 4.2, a few areas within the current water service area have the potential for growth beyond what has been defined in the OCP. The zones impacted by this potential densification are the 84 m Centre, 138 m east, and 122 m Fern zones.

The additional build-out demands have been established using the following assumptions:

1. Additional population for the 84 m Centre, 138 m East, and 122 m Fern zones are 4,700, 746, and 1,316 capita respectively;
2. Base and seasonal demands are distributed to each zone as a function of the percentage of total population (e.g. 122 m Fern includes 19.5% of the additional densification population; therefore, 19.5% of the total demand has been assigned to the zone);
3. Base residential (metered) demand unit rate = 250 L/ca/day;
4. Gross area = 230 ha;
5. Irrigable area = 24 ha; and
6. Seasonal demand unit rate = 0.47 L/s/ha.

It is noted that no additional seasonal demand was attributed to ICI lots; the additional SD is the result of single-family parcels changing to multi-family.

In order to assess the impact of the increase in demand, a scenario was created in the model, with additional demand added to the applicable zones as summarized in Table 11-10 below.

Table 11-10: Possible Densification Demand Summary

Zone	Additional 2041 BD L/s	Additional 2041 SD L/s	Location	Model Node
84 m Centre	13.2	7.9	128 Avenue around 238 Street	J-2681
138 m East	3.7	1.2	125 Avenue around 243 Street	J-4940
122 m Fern	2.1	2.2	Fern Crescent around 129 Avenue	J-4942
Total	19.0	11.3	-	-

The impact of the additional demand was checked with the proposed capital projects in place, in order to confirm the sizing of proposed water main upgrades. The possible densification does not change the size of proposed water main projects, but does have impacts on sizing of future facilities. The applicable tables in Appendix E include columns that present the additional demand and demonstrate the impact on reservoir and pump station capacities. The impact on key facilities is summarized in Table 11-11 below.





Table 11-11: Comparison of OCP With and Without Optional Densification



Location	2041 Concern	2041 Concern with Possible OCP Densification
246 Street Pump Station	Not deficient	Not deficient
236 Street Pump Station	10 L/s	15 L/s
246 Street Reservoir	2,387 m ³	2,956 m ³
Rockridge Reservoir	Not deficient	Not deficient
263 Street Reservoir	180 m ³	296 m ³

From the table above, it can be seen that the impact of the possible OCP densification would have a relatively minor impact on the required build-out facility sizing.



City of Maple Ridge Water Distribution Master Plan

Legend

-  Capital Project - Reservoir
-  Capital Project - Pump Station
-  Capital Project - PRV
-  Capital Project - Other

-  Capital Project - Watermain
-  Silver Valley Piping Extension

Water Main

-  < 300mm
-  300mm - 500mm
-  > 600mm

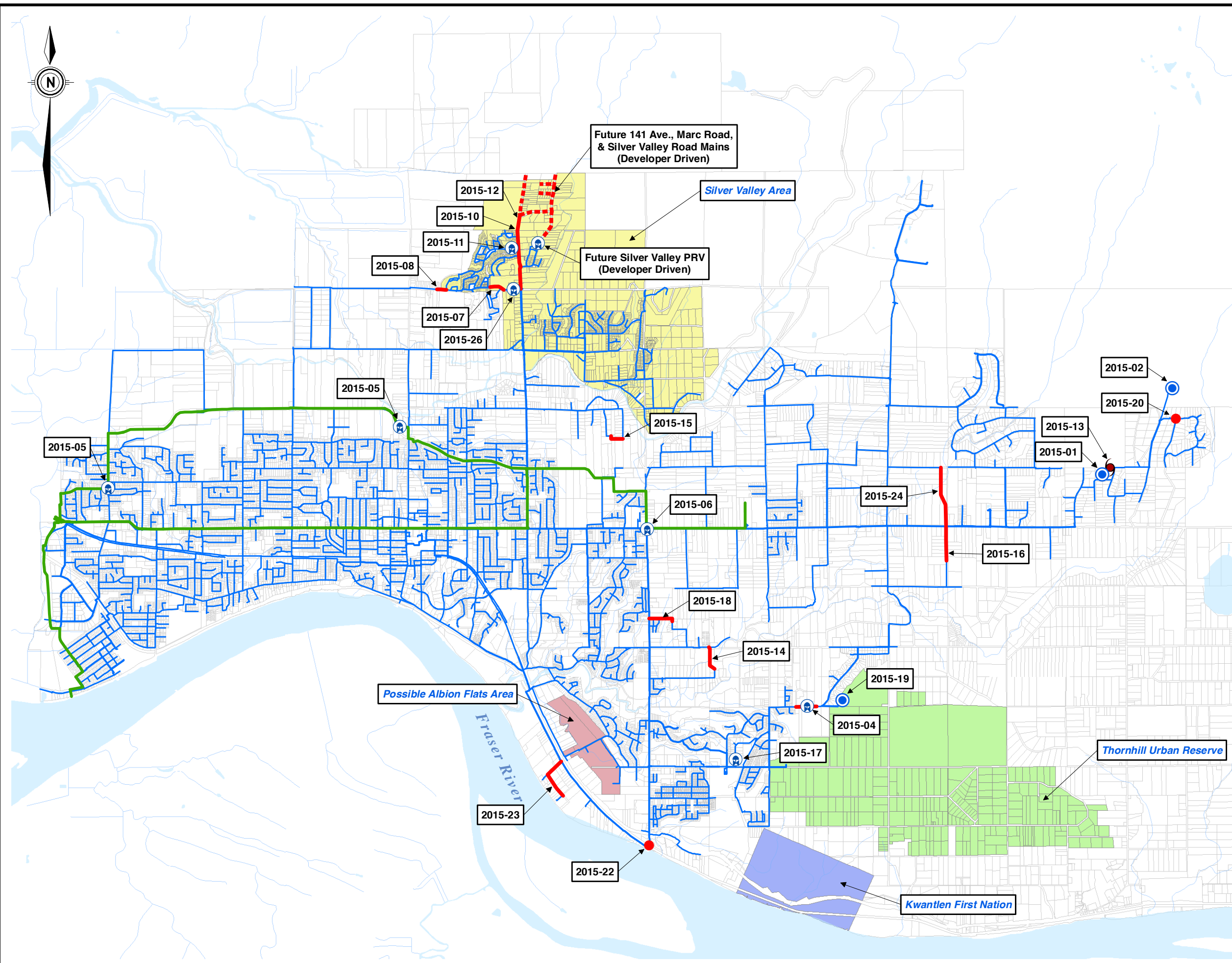

kwl KERR WOOD LEIDAL
consulting engineers
© 2016 Kerr Wood Leidal Associates Ltd.

Copyright Notice: These materials are copyright of Kerr Wood Leidal Associates Ltd. (KWL). City of Maple Ridge is permitted to reproduce the materials for archiving and for distribution to third parties only as required to conduct business specifically relating to the Drinking Water Master Plan Update. Any other use of these materials without the written permission of KWL is prohibited.

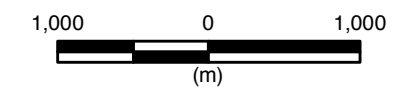

Project No. 173-164	Date November 2016
------------------------	-----------------------





Capital Tasks to Address Existing and Short-Term Growth

Figure 11-1



Path: O:\0100-0199\173-164\430-GIS\MXD-Rp173164_Figure11-1_CapitalTasksToAddressExistingConcerns.mxd Date Saved: 11/18/2016 2:16:25 PM Author: tsch

City of Maple Ridge Water Distribution Master Plan

Legend

-  Capital Project - Reservoir
-  Capital Project - Pump Station
-  Capital Project - PRV
-  Capital Project - Watermain

Watermain

-  < 300
-  300mm - 500 mm
-  > 600mm

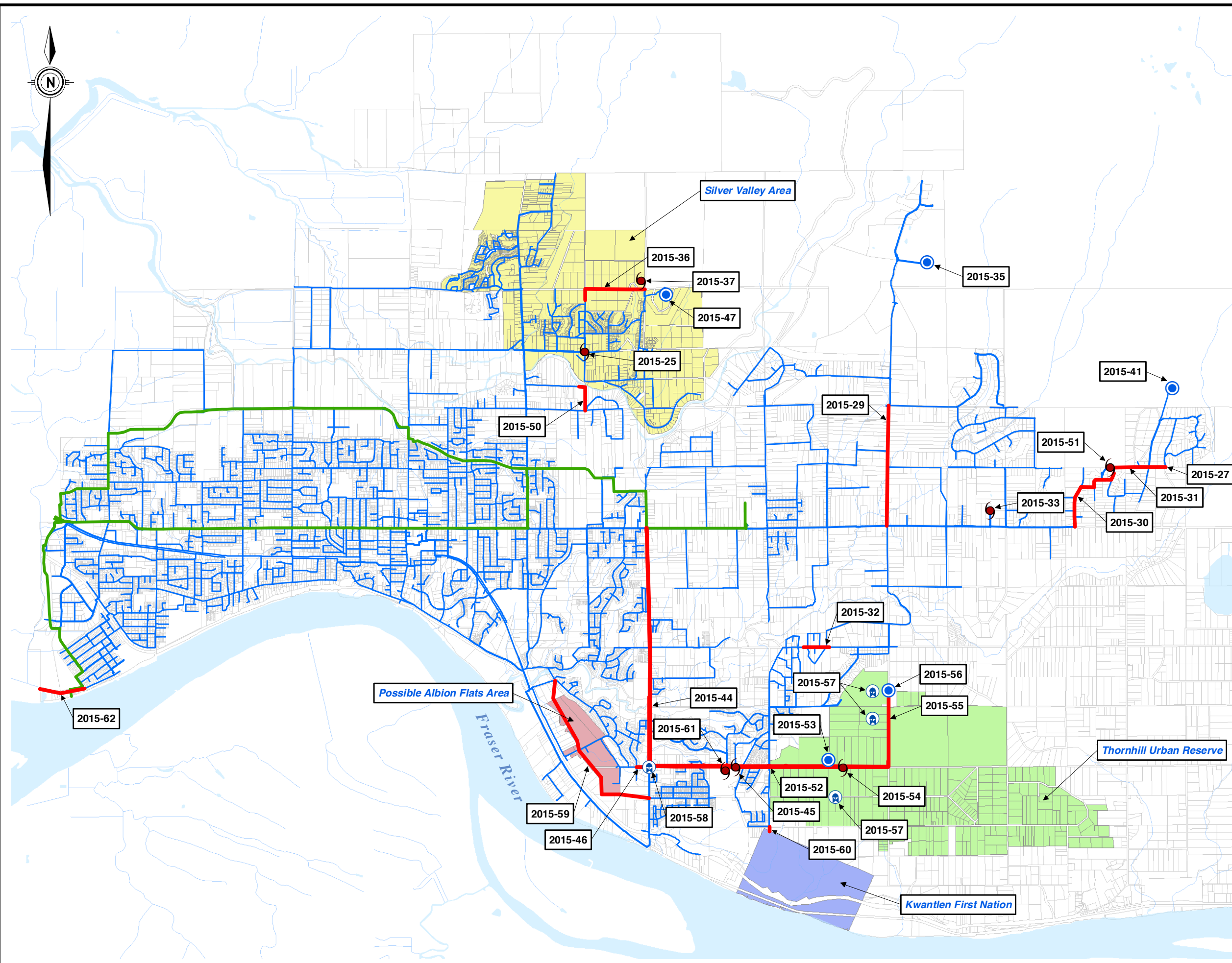

Copyright Notice: These materials are copyright of Kerr Wood Leidal Associates Ltd. (KWL). City of Maple Ridge is permitted to reproduce the materials for archiving and for distribution to third parties only as required to conduct business specifically relating to the Drinking Water Master Plan Update. Any other use of these materials without the written permission of KWL is prohibited.

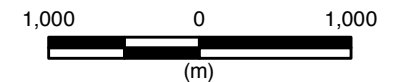

Project No.
173-164

Date
November 2016

Capital Tasks to Address Future Growth

Figure 11-2

Path: C:\0100-0199\173-164\430-GIS\MXD-Rp173164_Figure11-3_PeakHrDemandPressure_UpdatedSystem.mxd Date Saved: 17/06/2016 2:42:15 PM
 Author: R.Taylor

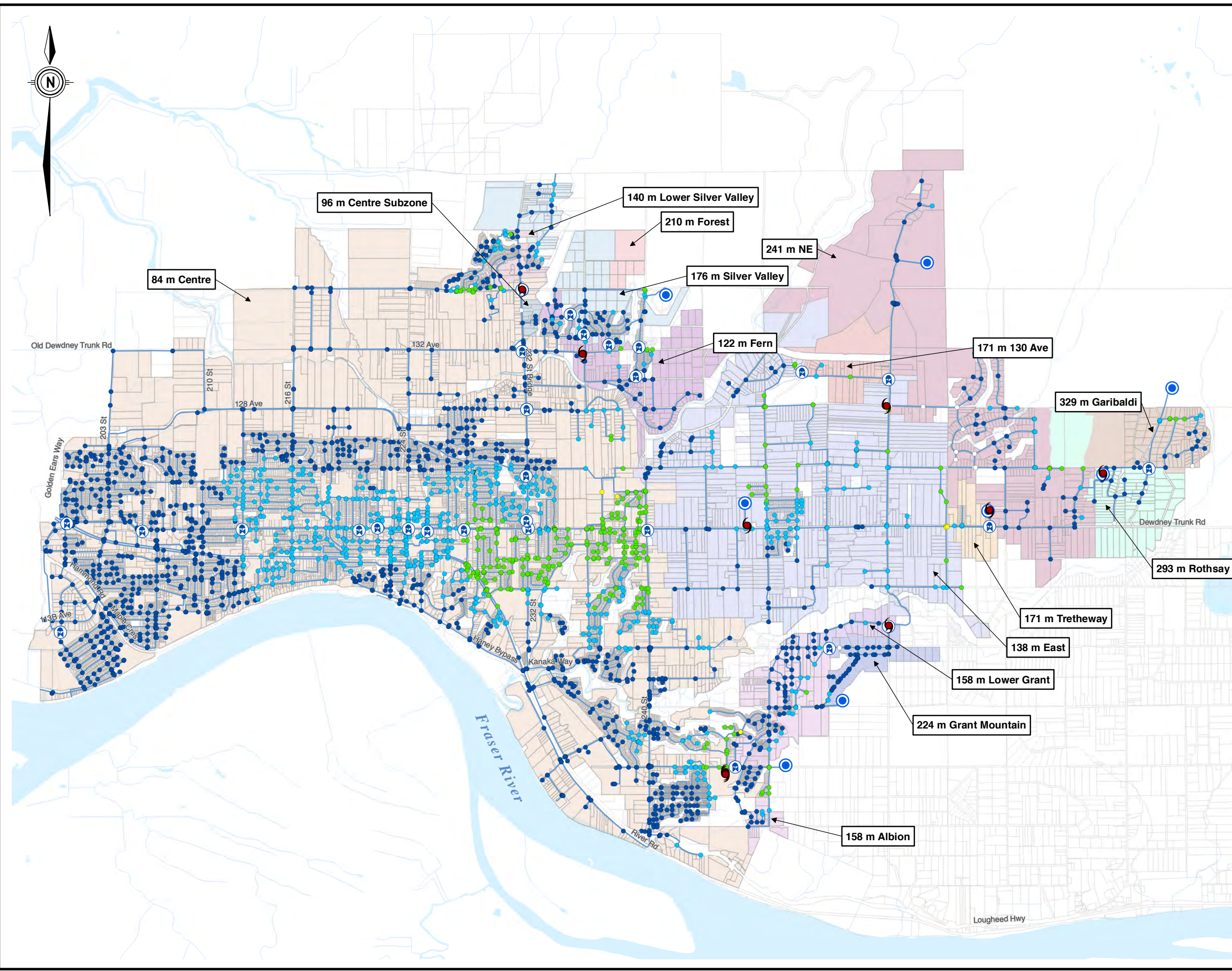

City of Maple Ridge Water Distribution Master Plan

Legend

- Water Main
- Existing Booster Pump Station
- Existing Reservoir
- Existing PRV

Peak Hour Pressure (psi)

- < 20
- 20 - 44
- 44 - 60
- 60 - 80
- 80 - 150
- > 150

Pressure Zone

- | | | | |
|--|--------------------------|--|----------------------|
| | 84 m Centre | | 171 m 130 Ave |
| | 96 m Centre Subzone | | 171 m Tretheway |
| | 122 m Fern | | 176 m Silver Valley |
| | 138 m East | | 210 m Forest |
| | 140 m Silver Valley West | | 224 m Grant Mountain |
| | 158 m Albion | | 241 m NE |
| | 158 m Lower Grant | | 293 m Rothsay |
| | | | 329 m Garibaldi |



Copyright Notice: These materials are copyright of Kerr Wood Leidal Associates Ltd. (KWL), City of Maple Ridge is permitted to reproduce the materials for archiving and for distribution to third parties only as required to conduct business specifically relating to the Drinking Water Master Plan Update. Any other use of these materials without the written permission of KWL is prohibited.

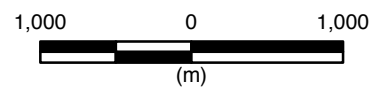

Project No.
173-164

Date
June 2016

Peak Hour Pressures with Upgraded System and Year 2041 Demands

Figure 11-3

Path: C:\0100-0199\173-164\430-GIS\MXD-Rp173164_Figure11-4_AvailableFireFlow_UpgradeSystem.mxd Date Saved: 17/06/2016 2:43:00 PM
 Author: FTaylor

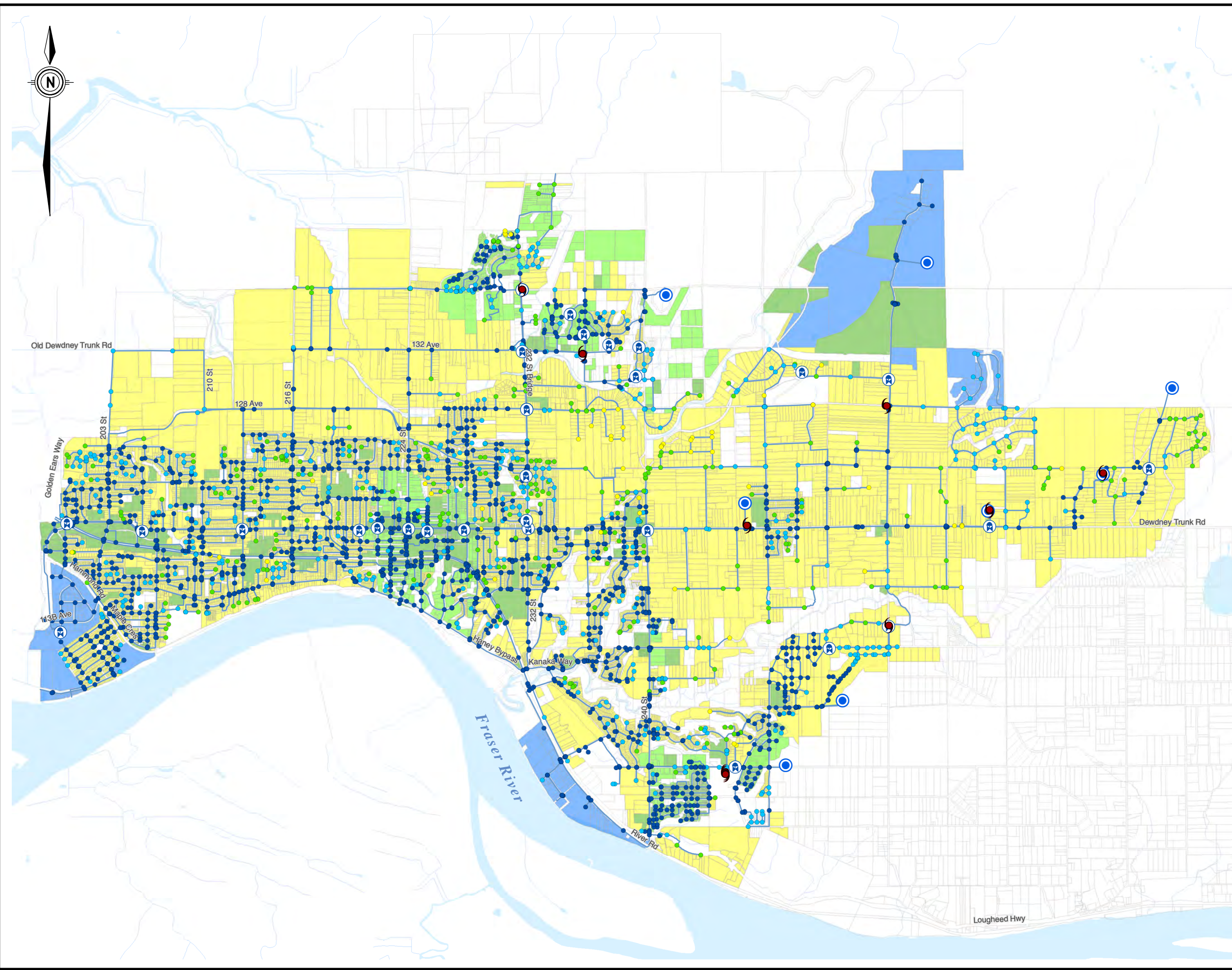

City of Maple Ridge Water Distribution Master Plan

Legend

- Water Main
- Existing Booster Pump Station
- Existing Reservoir
- Existing PRV

Fire Flow (L/s)

- 1 - 60 (Unacceptable)
- 60 - 90 (Res. Single Family Only)
- 90 - 150 (Residential)
- 150 - 225 (All Except Industrial)
- > 225 (All)

Zoning Type / Required Fire Flow

- Single Family Residential (60 L/s)
- Multi-Family Residential (120 L/s)
- Commercial / Institutional (150 L/s)
- Industrial (225 L/s)

Criteria for Pressure at Required Fire Flow :
 Minimum residual pressure 150 kPa (22 psi)
 Minimum zone pressure 150 kPa (22 psi)



Copyright Notice: These materials are copyright of Kerr Wood Leidal Associates Ltd. (KWL), City of Maple Ridge is permitted to reproduce the materials for archiving and for distribution to third parties only as required to conduct business specifically relating to the Drinking Water Master Plan Update. Any other use of these materials without the written permission of KWL is prohibited.

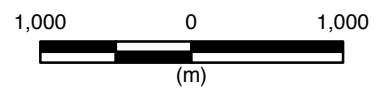

Project No. 173-164	Date June 2016
------------------------	-------------------

**Available Fire Flow
with Upgraded System
and Year 2041 Demands**

Figure 11-4



12. Recommended Master Plan

12.1 Scope of Master Plan

The Water Distribution Master Plan outlined in this report recommends system upgrades that address four key areas:

1. existing peak hour pressure or available fire flow;
2. existing pump supply or reservoir storage;
3. reliability and other improvements; and
4. improvements recommended to meet future demands.

Capital projects required to meet future demands include supply and storage improvements as well as distribution main expansion projects, redundancy improvements, and other miscellaneous projects.

Table 12-1 summarizes the capital costs by purpose. Note that servicing costs for Albion Flats and KFN are not included in this summary, as they relate to as of yet unapproved development (not currently part of the OCP). Total costs also do not include rehabilitation/replacement associated with asset management programs.

Table 12-1: Capital Plan Cost Summary

Category	Total Cost
Short Term Growth	\$7,120,000
Future Growth	\$10,920,000
Thornhill Urban Reserve Projects	\$17,560,000

Note: Thornhill cost allows for servicing to Thornhill, but not distribution within Thornhill.

12.2 Recommendations

It is recommended that the capital tasks identified in this master plan be used as a basis for the City's capital planning requirements. It is anticipated that the master plan will be updated periodically to account for changing demands and updated development plans.

In addition to the capital tasks, it is further recommended that:

1. Detailed reservoir siting studies be completed for those reservoirs that have multiple proposed expansion phases, in order to optimize the location and sizing of each new cell and determine if existing reservoirs should be replaced as part of the expansion;
2. An investigation be completed into the potential un-regulated connection between the MV system and the 84 m Centre Zone;
3. Conceptual design of facility upgrades be completed as design conditions for specific areas and developments become known; and
4. A review of the master plan projects be completed in light of asset management and infrastructure renewal requirements.



12.3 Report Submission

Prepared by:

KERR WOOD LEIDAL ASSOCIATES LTD.

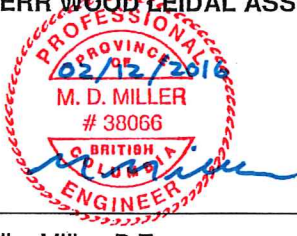

Mike Miller, P.Eng.
Project Engineer

Reviewed by:

Eric Morris, M.A.Sc., P.Eng.
Technical Reviewer

This document is a copy of the sealed and signed hard copy original retained on file. The content of the electronically transmitted document can be confirmed by referring to the filed original.



Statement of Limitations

This document has been prepared by Kerr Wood Leidal Associates Ltd. (KWL) for the exclusive use and benefit of the City of Maple Ridge for the Water Distribution Master Plan. No other party is entitled to rely on any of the conclusions, data, opinions, or any other information contained in this document.

This document represents KWL's best professional judgement based on the information available at the time of its completion and as appropriate for the project scope of work. Services performed in developing the content of this document have been conducted in a manner consistent with that level and skill ordinarily exercised by members of the engineering profession currently practising under similar conditions. No warranty, express or implied, is made.

Copyright Notice

These materials (text, tables, figures and drawings included herein) are copyright of Kerr Wood Leidal Associates Ltd. (KWL). The City of Maple Ridge is permitted to reproduce the materials for archiving and for distribution to third parties only as required to conduct business specifically relating to Water Distribution Master Plan. Any other use of these materials without the written permission of KWL is prohibited.

Revision History

Revision	Date	Status	Revision	Author
1	November 21, 2016	Final	Revised to address additional City comments.	MDM/ABB
A	February 3, 2016	Draft	Original	JEF/MDM





KERR WOOD LEIDAL
consulting engineers

Appendix A

Summary of Existing Facilities

City of Maple Ridge

Table A-1: Summary of Water Pump Stations

Pump	Feeds Zone	Station Name	Element	Pump Make / Model	Source Zone	Model ID	Initial Status - EPS Model Scenario	Initial Status - MDD + Fire Flow Model Scenario	Notes
	241 m NE	263 Street		263 #1		138 m East	2858	Off	Off
263 #2					2859		On	Off	
329 Garibaldi	270A Street		270A #1		241 m NE	2866	On	Off	
			270A #2			2867	Off	Off	
138 m East	246 Street		246 #1		MV Supply	2870	On	Off	
			246 #2			2869	Off	Off	
			246 #3			2868	Off	Off	
158 m Albion	Albion		Albion #1	Grundfos CR45-3-2	84 m Centre	6547	On	Off	
			Albion #2	Grundfos CR45-3-2		7106	Off	Off	
			Albion #3	Grundfos CR64-3-2		6548	Off	Off	
			Albion #4	Grundfos CR64-3-2		6549	Off	Off	
241 m NE	256 Street		256 #1		138 m East	6470	Off	Off	
			256 #2			6478	On	Off	
140 m Lower Silver Valley	232 Street		232 #1	Grundfos CR64-2	96 m Centre Sub-zone	7106	Off	Off	Emergency use only
			232 #2	Grundfos CR64-2		Not in model	N/A	N/A	Emergency use only
176 m Silver Valley (Rockridge)	236 Street		236 #1		96 m Centre Sub-zone	2879	On	Off	
			236 #2			19836	Off	Off	
			236 #3			19841	Off	Off	Fire pump originally
224 m Grant Mountain	Grant Mountain		Grant Mountain #1	Grundfos CR64-3-1	134 m East	18732	On	Off	
			Grant Mountain #2	Grundfos CR64-3-1		18733	Off	Off	

Table A-2: Summary of Reservoirs

Zone	Facility Name	Reference Drawing Provided (Y/N)	Reference Drawing	Top Water Level Elevation (m)	Base Elevation (m)	Modelled Volume (m ³)	Initial Water Elevation - MDD / EPS Model Scenario	Initial Water Elevation - Fire Flow Model Scenario
84 m Centre	246 Street MV Reservoir	Y	WF- 1463	96.2	89.4	22,897	94.50	89.40
138 m East	263 Street Reservoir	Y	173.83.1 Sheet 6 of 8	137.9	132.0	2,186	137.39	135.00
241 m NE (South)	270A Street Reservoir	Y	3723	241.5	232.0	600	240.81	236.00
329 m Garibaldi	McNutt Reservoir	Y	S99-667-GA1	329.6	323.2	633	327.61	327.30
241 m NE (North)	256 Street Reservoir	Y	3018, 6814	240.7	230.2	2,532	240.15	235.95
158 m Albion	Albion Reservoir	Y	6317, 6909	158.0	154.0	1,290	156.00	156.50
176 m Silver Valley	Rockridge Reservoir	Y	7725	177.8	169.0	1,451	175.00	172.00
224 m Grant Mountain	Grant Mountain Reservoir	Y	8182	224.0	219.2	765	223.90	223.90

O:\0100-0199\173-164\300-Report\WaterMasterPlanReport\FINAL_Report_Rev1\Figures&Tables\AppendixA_FacilitySummary.xlsx\TbIA-2_Reservoirs

Table A-3: Summary of PRV Valve Data

	PRV Feeds Zone	Station Name	Station Code	Model ID	Station Elevation (m)	Size (inches)	Size (mm)	Model HGL Setting (m)
PRV	84 m Centre	Kingston Street	1	6945	1.8	8	200	84
	84 m Centre	DTR & Lougheed Hwy	2	2897	4.5	10	250	72
			2a	7558	4.5	4	100	80
	84 m Centre	DTR & 206 St.	3	2899	17.3	8	200	78
	84 m Centre	DTR & Laity St.	4	2896	30.5	8	200	83.3
			4a	2895	30.8	3	75	87.1
	84 m Centre	DTR & 221 St.	5	2894	36.6	8	200	80.3
	84 m Centre	DTR & 222 St.	6	2886	35.6	12	300	84.9
			6a	2901	35.6	8	200	88.4
	84 m Centre	DTR & 224 St.	7	2893	37.8	6	150	87.1
	84 m Centre	DTR & Edge St.	8	2892	39.1	10	250	81.4
			8a	2903	39.1	4	100	89.8
	84 m Centre	DTR & 228 St.	9	2891	45.3	8	200	81.9
			9a	2902	45.3	6	150	89
	84 m Centre	DTR & 232 St.	10	2883	43.85	12	300	87.5
			10a	2904	43.85	6	150	96
	84 m Centre	232 St. & Cherrywood	11	2890	40.8	6	150	90.1
	84 m Centre	232 St. & 124 Ave.	12	2887	31.8	6	150	84.6
	84 m Centre	232 St. & 128 Ave.	13	7573	17.52	8	200	73.9
			13a	19906	17.52	2	50	77.4
	84 m Centre	DTR & 240 St.	14	17952	56	12	300	89.6
	84 m Centre	232 St. & 132 Ave.	15	2888	15.2	8	200	85.6
	122 m Fern	241 St. & 125 Ave.	16	2913	56	4	100	122
	171 m Tretheway	DTR & 263 St.	17	2898	124.2	6	150	162.9
			17a	Not in model	124.2	2	50	-
	171 m 130 Ave.	256 St. & 130 Ave.	18	2885	111	6	150	153.3
			18a	Not in model	111	2	50	-
	293 m Rothsay	McNutt Rd. & 12400	20	2900	237	8	200	286.21
			20a	2905	237	2	50	292.5
	112 m Albion Sub-zone	245B St. & 104 Ave.	21	6384	62.7	6	150	112
			21a	Not in model	62.7	2	50	-
	96 m Centre Sub-zone	232 St. & Foreman Drive	22	2915	48	6	150	96
	122 m Fern	237A St. & 132A Ave.	23	2918	87	6	150	112
			23a	Not in model	87	2	50	-
	122 m Fern	239B St. & 132 Ave.	24	7175	78.21	6	150	120
			24a	Not in model	78.21	2	50	-
	122 m Fern	239B St. & 140 Ave.	25	7155	46.37	8	200	106.1
			25a	Not in model	46.37	2	50	-
	138 m East	130A Ave. & 130 Connector	26	2884	98.7	6	150	119.8
	-	Rothsay St. & 122 Ave.	29	Not in model	98.7	4	100	-
	122 m Fern	13458 235 St.	30	19342	78.3	6	150	120
			30a	Not in model	78.3	3	75	-
	122 m Fern	236 St. & Larch Ave.	31	19619	73.7	8	200	120
			31a	Not in model	-	3	75	-
	224 m Grant Mountain	252 St. & 112 Ave.	32	18736	94.81	6	150	151.15
			32a	7056	94.81	2	50	154.67
	84 m Centre	203 St. & Telep Ave.	xx	16414	12.89	12	300	78
			xxa	16414	12.89	12	300	78
140 m Lower Silver Valley	232 St. Pump Station	xx	6603	46.1	8	200	140	
		xxa	19708	47.09	3	75	142	
84 m Centre	224 St. & 127 Ave.	xx	16416	7.3	12	300	80	



KERR WOOD LEIDAL
consulting engineers

Appendix B

Water Main Piping Inventory and Model Output

Project Inventory: DMR_2014_v3.47.wtg

Title	District of Maple Ridge Water Model
Engineer	Neal Whiteside / Jonathan Funk
Company	KWL
Date	19/11/2010
Notes	

Scenario Summary

ID	7583
Label	2014 System + 2013 MDD Steady State * Updated Aug 2014 by JEF (KWL)
Notes	Updated demands to 2013 observed. Numerous physical changes (See model log). Previous notes: 2013 model re-build, built off 2011 model includes some decommissioned pipes / upgrades since 2011, MDD 2010 Demands
Active Topology	17939: 2014 System
Physical	17948: 2015 Existing System
Demand	20151: 2013 Existing Demand
Initial Settings	17915: 232 HP Main Isolation, MV Supply 95 m HGL
Operational	114: Base-Operational (2007 Control)
Age	128: Base-Age Alternative
Constituent	129: 2014 Existing Chlorine Const.
Trace	139: Base-Trace Alternative
Fire Flow	140: Base-Fire Flow
Energy Cost	149: Base-Energy Cost
Transient	6640: Base HAMMER
Pressure Dependent Demand	150: Base Pressure Dependent Demand
Failure History	18974: Base Failure History
SCADA	20175: Base SCADA
User Data Extensions	17964: 2011 Upgrades
Steady State/EPS Solver Calculation Options	19465: Steady State
Transient Solver Calculation Options	6639: Base

Network Inventory

Pipes	3980	-Standard Extended	0
Junctions	3172	-Constant Speed - No Pump Curve	28
Hydrants	0	-Constant Speed - Pump Curve	0
Tanks	11	-Shut Down After Time Delay	0
-Circular	4	-Variable Speed/Torque	0
-Non-Circular	6	-Pump Start - Variable Speed/Torque	0
-Variable Area	1	Pump Stations	0
Reservoirs	11	Variable Speed Pump Batteries	0
Customer Meters	0	PRV's	63

Project Inventory: DMR_2014_v3.47.wtg

Network Inventory			
SCADA Elements	0	PSV's	0
Pumps	28	PBV's	0
-Constant Power	0	FCV's	7
-Custom Extended	0	TCV's	1
-Design Point (1 Point)	14	GPV's	0
-Multiple Point	11	Isolation Valves	0
-Standard (3 Point)	3	Spot Elevations	0
Transient Network Inventory			
Turbines	0	Rupture Disks	0
Periodic Head-Flows	0	Discharges to Atmosphere	0
Air Valves	0	Orifices Between Pipes	0
Hydropneumatic Tanks	0	Valves With Linear Area Change	0
Surge Valves	0	Surge Tanks	0
Check Valves	0		
Pressure Pipes Inventory			
50.0 (mm)	425.0 m	254.5 (mm)	48.5 m
76.0 (mm)	0.5 m	265.0 (mm)	1,677.5 m
101.6 (mm)	1,252.7 m	268.7 (mm)	38,175.3 m
102.0 (mm)	4.0 m	269.0 (mm)	29.0 m
102.3 (mm)	6.0 m	304.8 (mm)	105.1 m
109.2 (mm)	520.5 m	316.0 (mm)	549.0 m
150.0 (mm)	757.0 m	321.0 (mm)	281.0 m
152.0 (mm)	4.5 m	321.1 (mm)	27,817.5 m
152.4 (mm)	52,803.0 m	336.6 (mm)	36.5 m
154.1 (mm)	51.7 m	374.4 (mm)	5,296.2 m
155.0 (mm)	2,940.5 m	387.4 (mm)	44.0 m
160.0 (mm)	1,152.5 m	426.7 (mm)	8,064.5 m
161.0 (mm)	12.0 m	479.6 (mm)	2,422.5 m
162.0 (mm)	135.5 m	499.0 (mm)	15.5 m
162.6 (mm)	95,494.5 m	531.9 (mm)	2,817.5 m
191.8 (mm)	101.0 m	590.6 (mm)	87.5 m
200.0 (mm)	1,155.0 m	641.4 (mm)	4,642.0 m
202.7 (mm)	61.5 m	692.2 (mm)	11.5 m
203.2 (mm)	6,945.5 m	743.0 (mm)	2,740.6 m
212.0 (mm)	8.0 m	895.4 (mm)	4,043.0 m
214.0 (mm)	2,767.5 m	902.0 (mm)	7,917.0 m
216.0 (mm)	1,609.0 m	1,050.0 (mm)	1.0 m
217.0 (mm)	1,624.5 m	1,200.2 (mm)	72.0 m
217.2 (mm)	135,924.5 m	1,352.6 (mm)	2,927.5 m
250.0 (mm)	76.5 m	All Diameters	417,440.1 m
254.0 (mm)	1,785.5 m		



KERR WOOD LEIDAL
consulting engineers

Appendix C

240 Street Flow Test Results (Email)

Jonathan Funk

From: Jonathan Funk
Sent: March-10-15 2:29 PM
To: 'Joe Dingwall'
Cc: Eric Morris; John Delver; File
Subject: RE: 240th Street Flow Testing Results - KWL File #0173.164

City of Maple Ridge 240th Street Corridor Flow Tests

Introduction

KWL is currently preparing a water master plan for the City of Maple Ridge using the City's hydraulic water model. One of the tasks in this assignment is validation of the model with field data. This validation work showed that there is a discrepancy between measured and modelled pressures and headlosses in the 240th Street corridor of the 84 m Centre Zone. In an effort to resolve the discrepancy, KWL and the City performed 4 hydrant flow tests as follows:

1. Hydrant flow test near Albion Pump Station
2. Pump Station + Hydrant flow test (pump activation in stages)
3. Pump Station flow test (McClure Drive Supply only)
4. Pump Station flow test (104th Ave Supply only)

During field testing, it was decided to perform a variation of Flow Test #2 wherein a second flow diffuser was used to increase the total flow demanded by the system near the Albion Pump Station. The second test is subsequently reported as "Flow Test 2a" (one hydrant diffuser) and "Flow Test 2b" (two hydrant diffusers). Note that the second diffuser does not have flow measurement capabilities. It is estimated that the diffuser delivered approximately 60 L/s.

Flow Test Results

Flow Test 1 - Single Hydrant - Timeline

10:26 AM

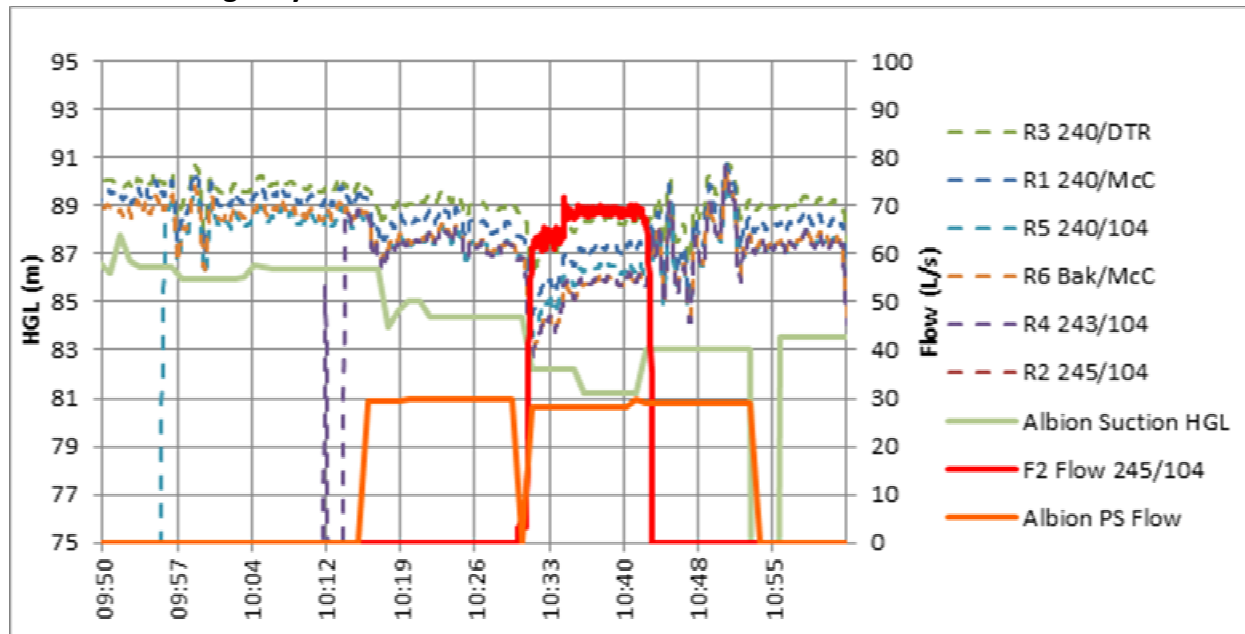

Flow Test 1 - Results

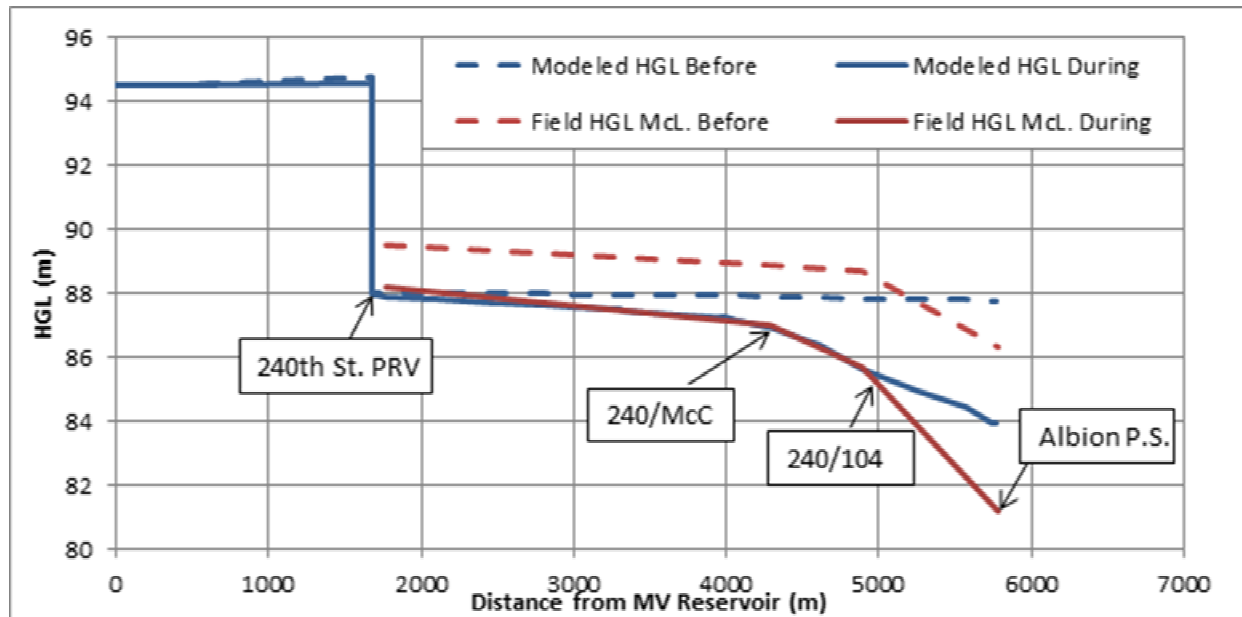

Flow Test 1 - Interpretation

Model is showing good agreement along 240th and McClure up to Baker.
 Modelled losses are low from Baker to Albion Pump Station along McClure
 Possible Error in field data for Albion Pump Station intake pressure data (pressures appear to be uncorrelated with pump station flow)

Summary: Fair model validation but data somewhat suspect close to Albion PS due to possible measured pressure inaccuracy at Albion PS

Flow Test 2a - 4 pumps + hydrant - Timeline

11:09 AM

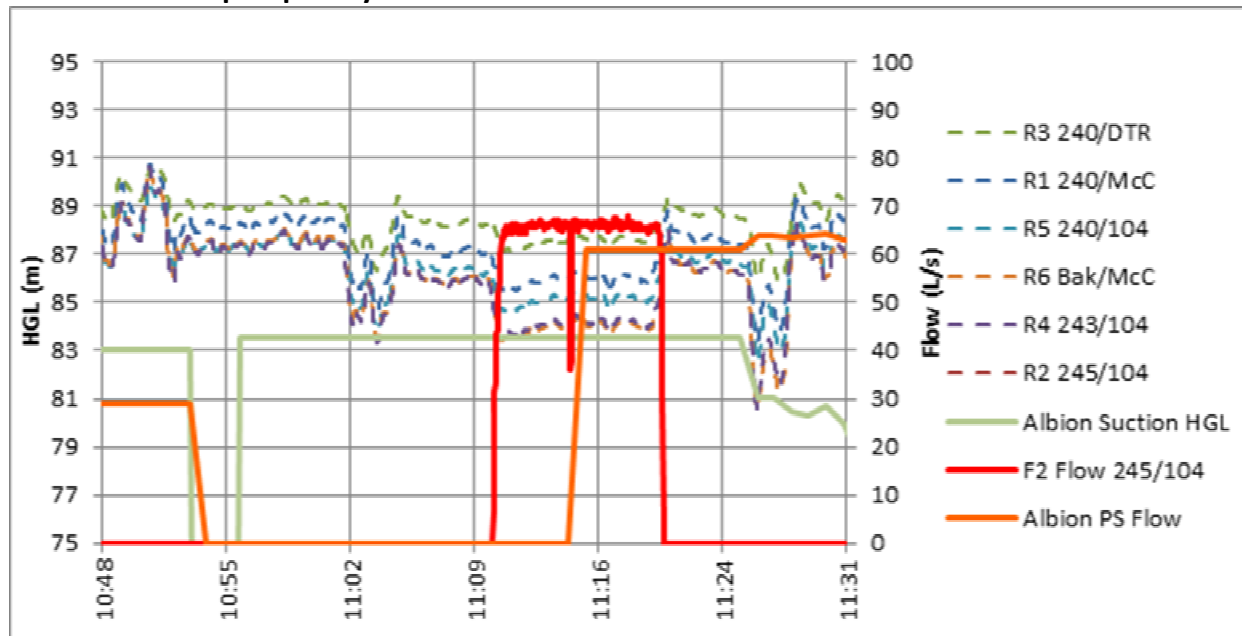

Flow Test 2a - Results

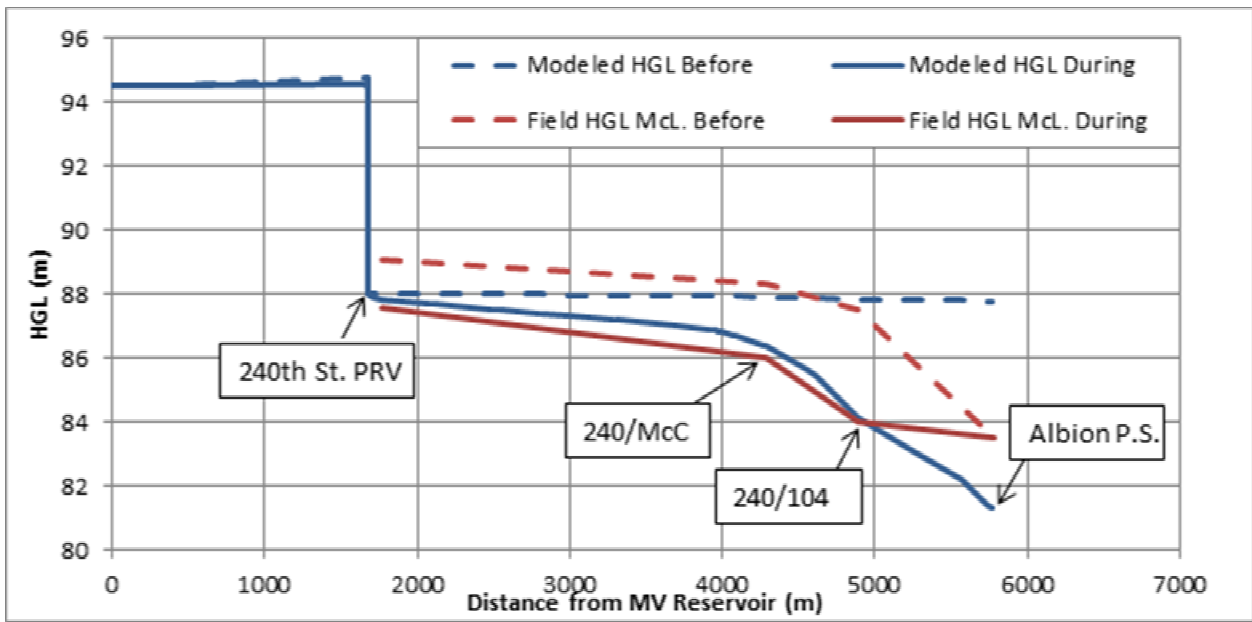

Flow Test 2a - Interpretation

Modeled losses on 240th are slightly low until McClure
 Modeled losses on McClure are slightly high until Baker
 Possible Error in field data for Albion Pump Station intake pressure data (again pressures appear to be uncorrelated with pump station flow)

Summary: Fair model validation but an increase headloss (decrease in C Factor) along 240th may be warranted.

Again data somewhat suspect close to Albion PS due to possible measured pressure inaccuracy at Albion PS

Flow Test 2b - 4 pumps + 2 hydrants - Timeline

11:35 AM

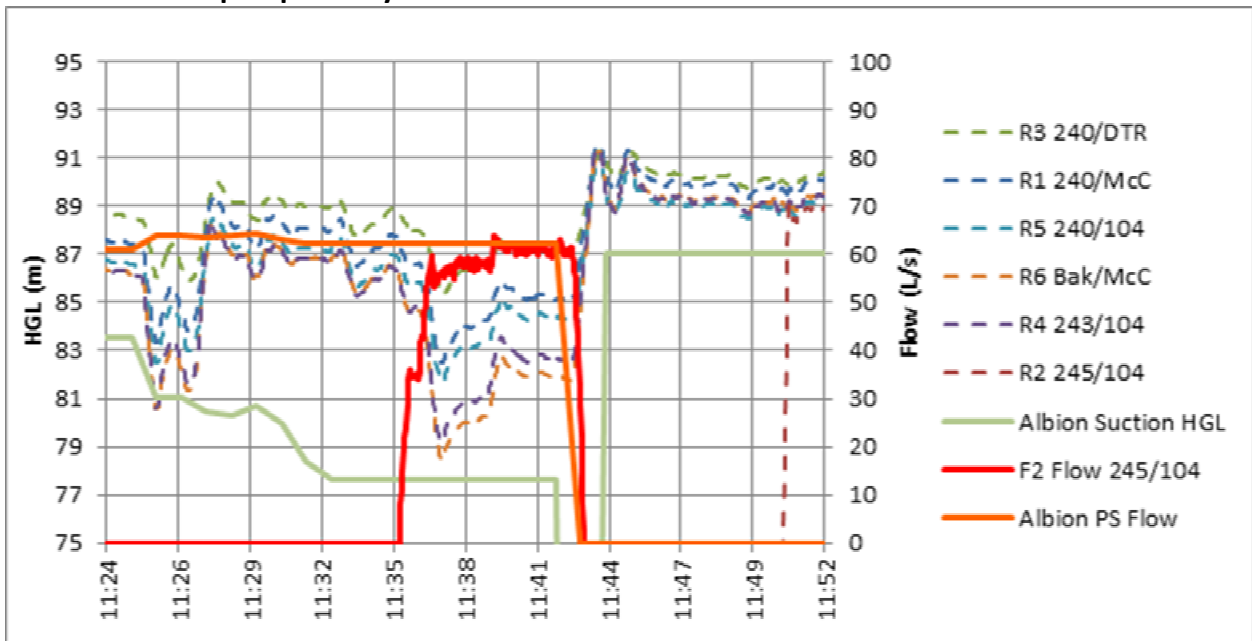

Flow Test 2b - Results

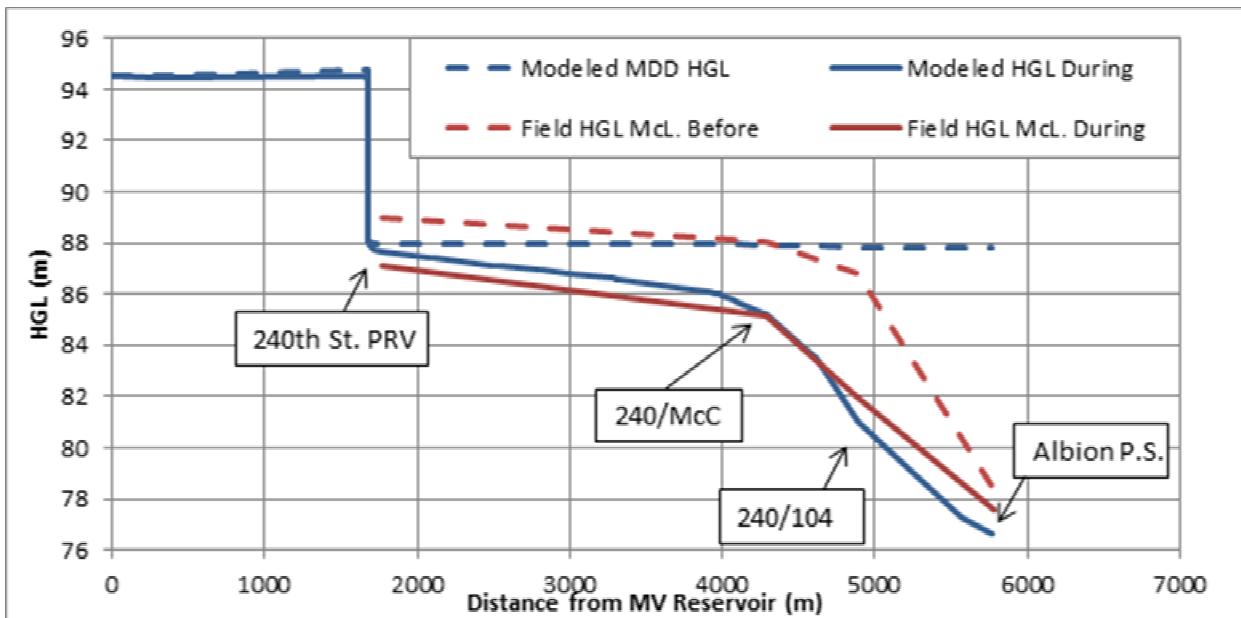

Flow Test 2b - Interpretation

Modeled losses on 240th and McClure are good (slightly low) until Baker.

Modeled losses between Baker and Albion P.S. are slightly higher than field, but in acceptable agreement.

Summary: Fair model validation but an increase headloss (decrease in C Factor) along 240th may be warranted. Again data somewhat suspect close to Albion PS due to possible measured pressure inaccuracy at Albion PS

12:15
AM

Flow Test 3 - Close line Valve on 104th - Timeline

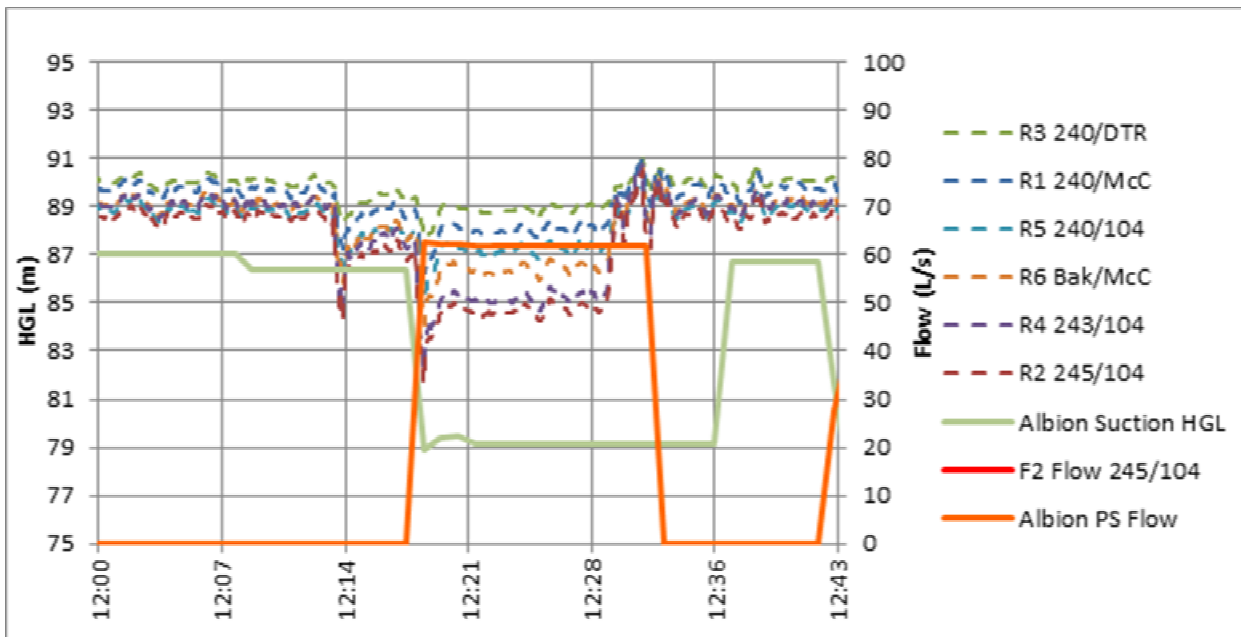

Flow Test 3 - Results

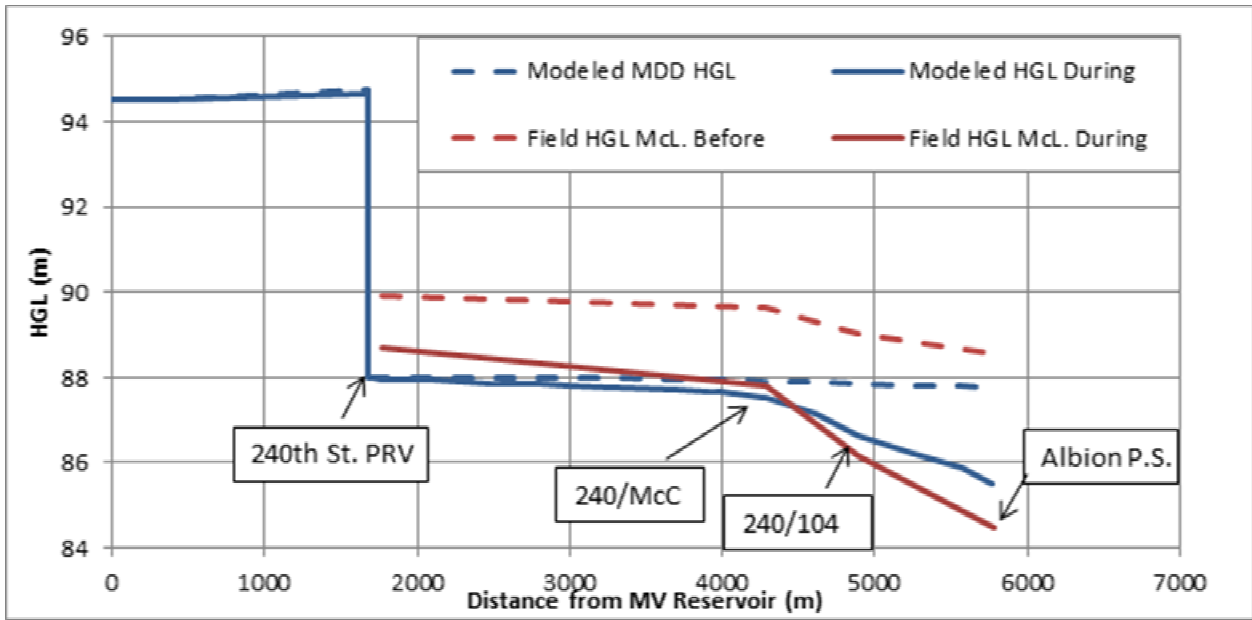

Flow Test 3 - Interpretation

Modeled losses on 240th and McClure are slightly low all the way to Albion Pump Station.

Summary: Small increase to headloss along 240th may be warranted.

Flow Test 4 - Close line vale on McClure - Timeline

12:40 AM

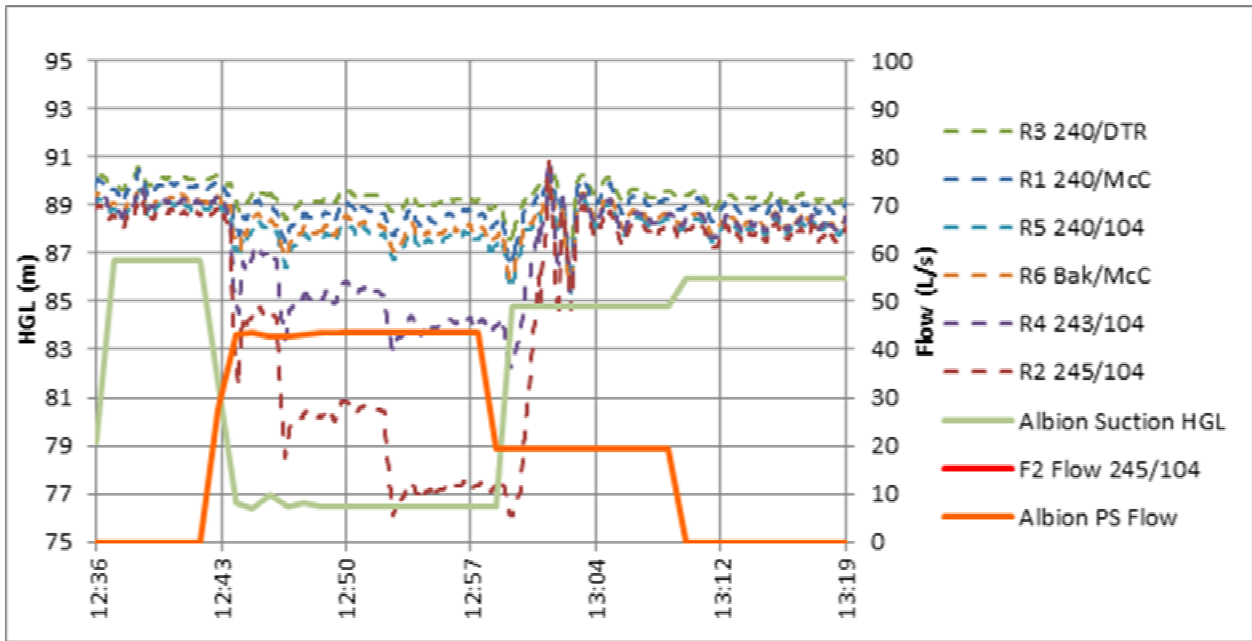

Flow Test 4 - Results

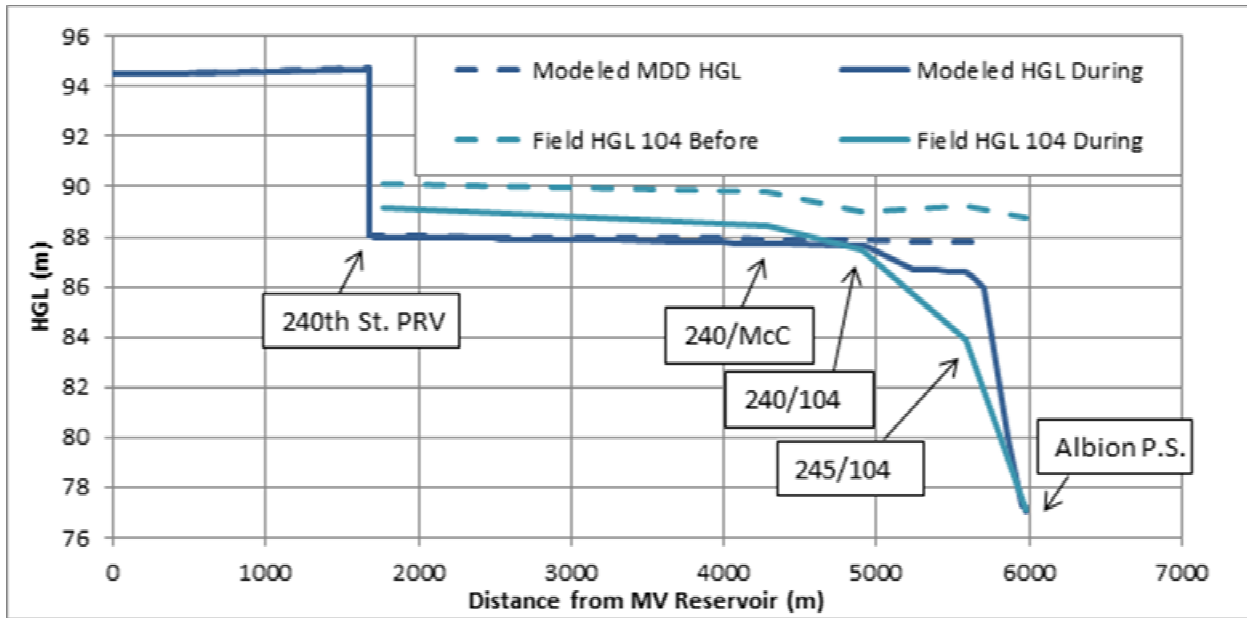

Flow Test 4 - Interpretation

Modeled losses along 240th street are low (Note there is a relatively low velocity in the 240th Street watermain in this test)
 Modeled losses between 240th and 245th are low compared to field data.
 Modeled losses between 245th and Albion pump station are high compared to field data.

Summary: Summary: Field measured headlosses are inconsistent with the model along 104th Ave and the discrepancy cannot be due to a closed valve or pipe blockage

Results and Conclusions

Based on the results presented above and some trial-and-error adjustments to the model, it was found that decreasing the Hazen Williams C along 240th street from 130 to 110 resulted in a better fit for headlosses overall.

Also, closing the 150mm AC watermain on 104th immediately east of 240th street improved the fit of results for all flow tests, and the final flow test in particular (See revised results below). It should be that this model run is a hypothesis and there is not enough data to determine with certainty exactly where the constriction is.

Flow Test 4 - Revised Results

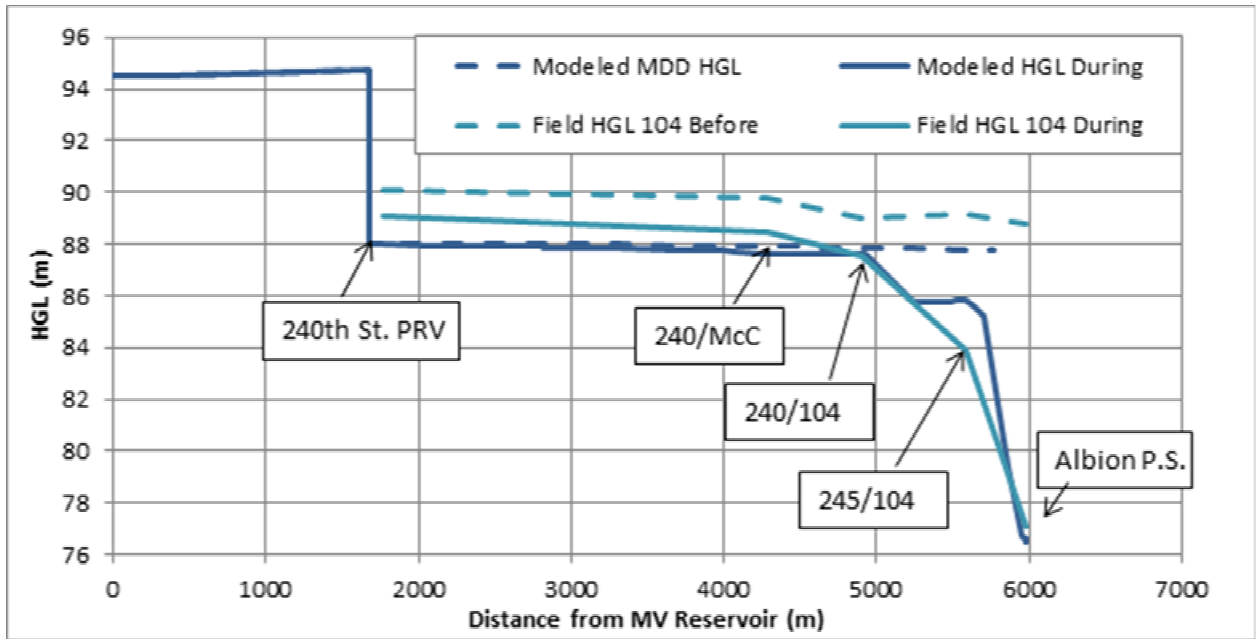

Based on the foregoing, we recommend proceeding with ongoing master planning work with the existing model after adjusting the Hazen William’s C on 240th to 110. We also recommend that further field testing be conducted to identify the reason for the model discrepancy close to the Albion Pump Station. The results of this hydrant testing and model validation work suggest that there is a localized flow constriction in this area, possibly due to a closed valve or pipe blockage. However, given that this constriction may be due to an operational/maintenance issue rather than a capacity deficiency (i.e. undersized watermains), we recommend that no adjustments be made to the model for the purpose of water system planning.

If you have any questions regarding this data or conclusions, please let me know.

Best Regards,

Jonathan Funk, B.A.Sc., EIT

Project Engineer

D 604 293 3108

www.kwl.ca

KERR WOOD LEIDAL

consulting engineers

The information in this message and/or its attachments is confidential. Use or disclosure of the contents by anyone other than the intended recipient is prohibited. If you have received this in error, please delete and notify the sender immediately.

KWL File # 0173.164



KERR WOOD LEIDAL
consulting engineers

Appendix D

Pressure Validation Data

Figure D-1: Site 1 Field vs. Model Data

Zones: 84m Centre Zone

Max Day Demand: 646 L/s

On July, 21, 2013

Location: Site 1 - 136th St.: 22620 136 Ave

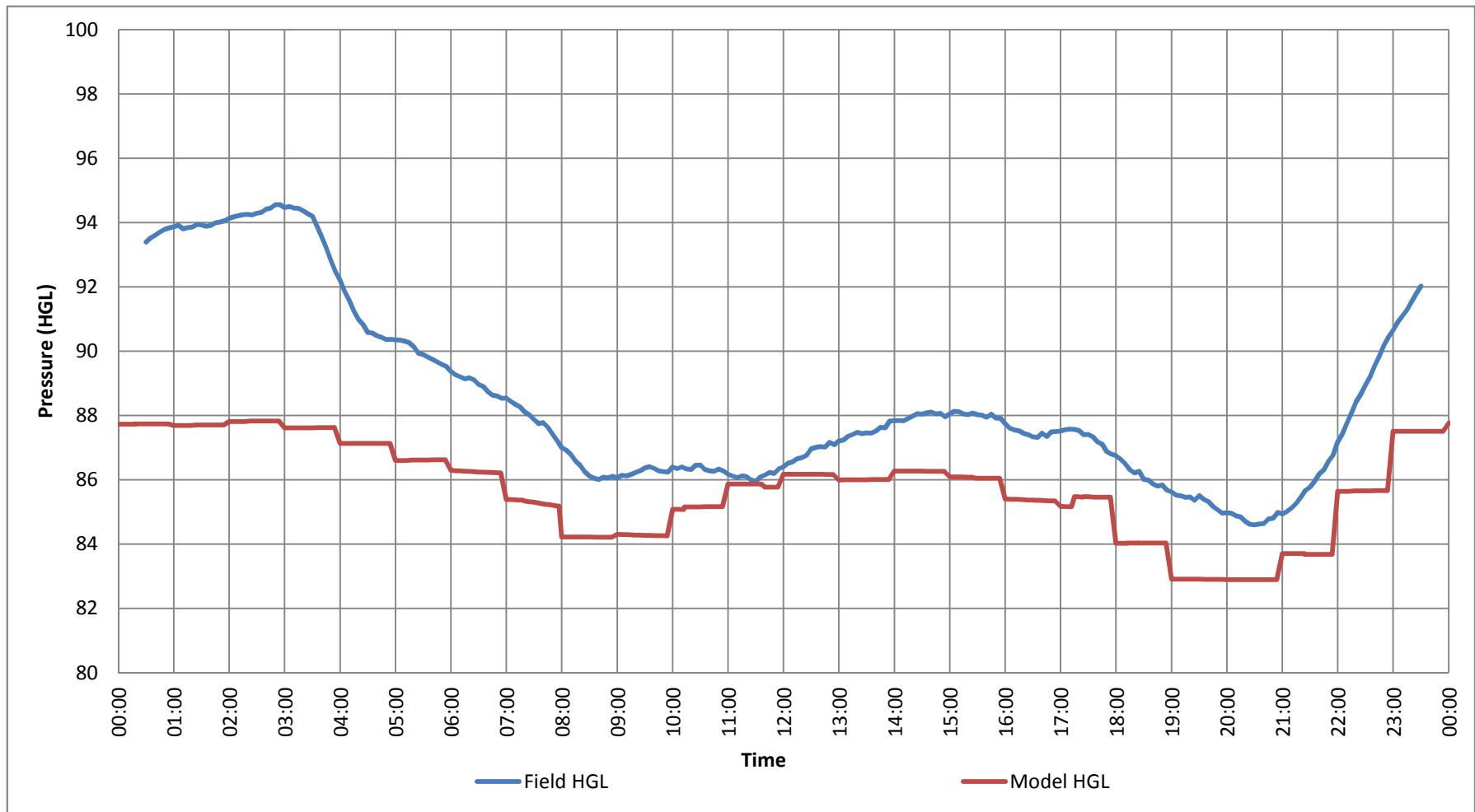

Figure D-2: Site 2 Field vs. Model Data

Zones: 84m Centre Zone

Max Day Demand: 646 L/s

On July, 21, 2013

Location: Site 2 - 207th St.: 20686 120B Ave

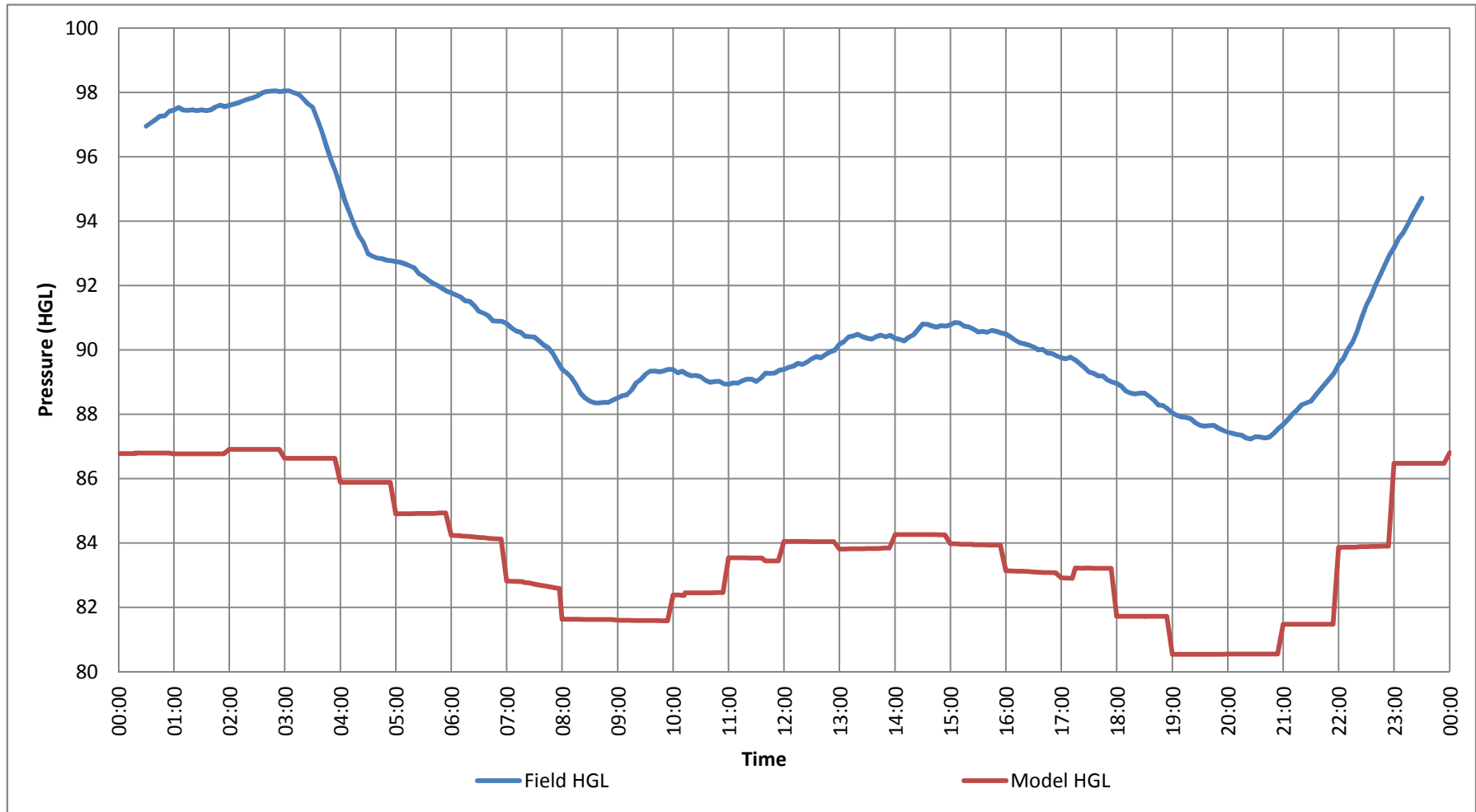

Figure D-5: Site 5 Field vs. Model Data

Zones: 84m Centre Zone

Max Day Demand: 646 L/s

On July, 21, 2013

Location: Site 5 - Albion Dike: 23402 Fisherman Rd

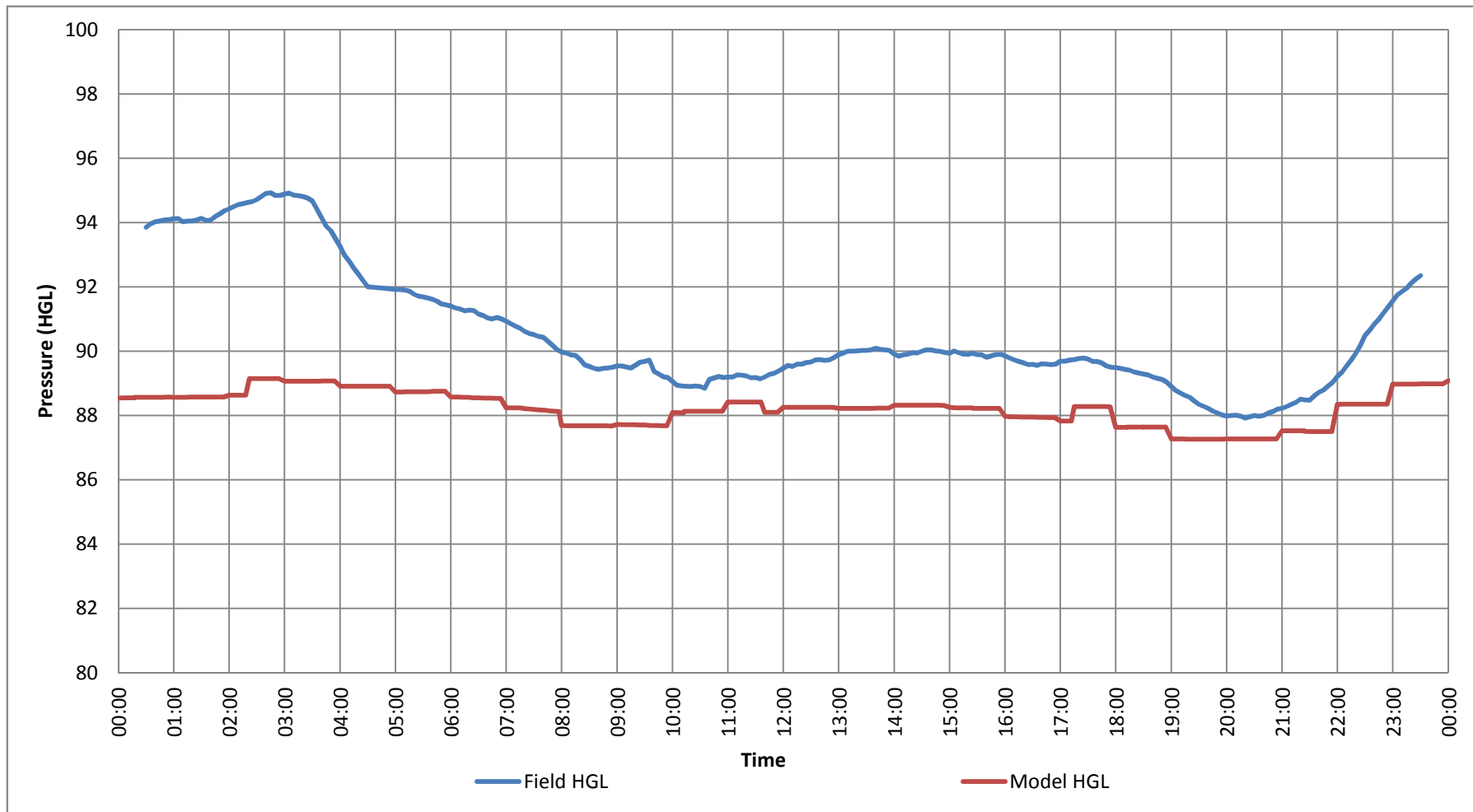

Figure D-6: Site 6 Field vs. Model Data

Zones: 84m Centre Zone

Max Day Demand: 646 L/s

On July, 21, 2013

Location: Site 6 - Cliff Avenue: 22010 Cliff Ave

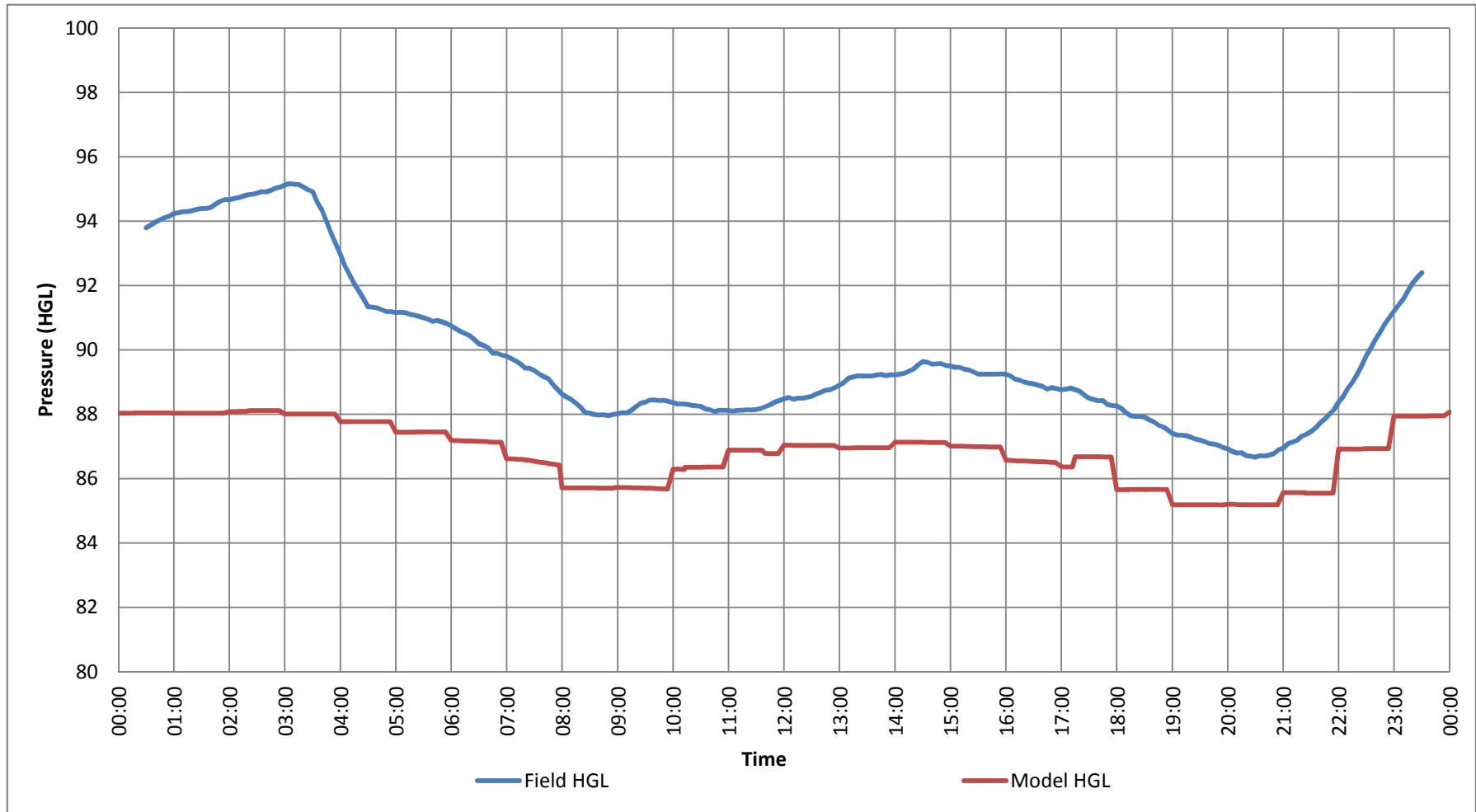

Figure D-7: Site 7 Field vs. Model Data

Zones: 84m Centre Zone

Max Day Demand: 646 L/s

On July, 21, 2013

Location: Site 7 - Cutler: 21198 Cutler Place

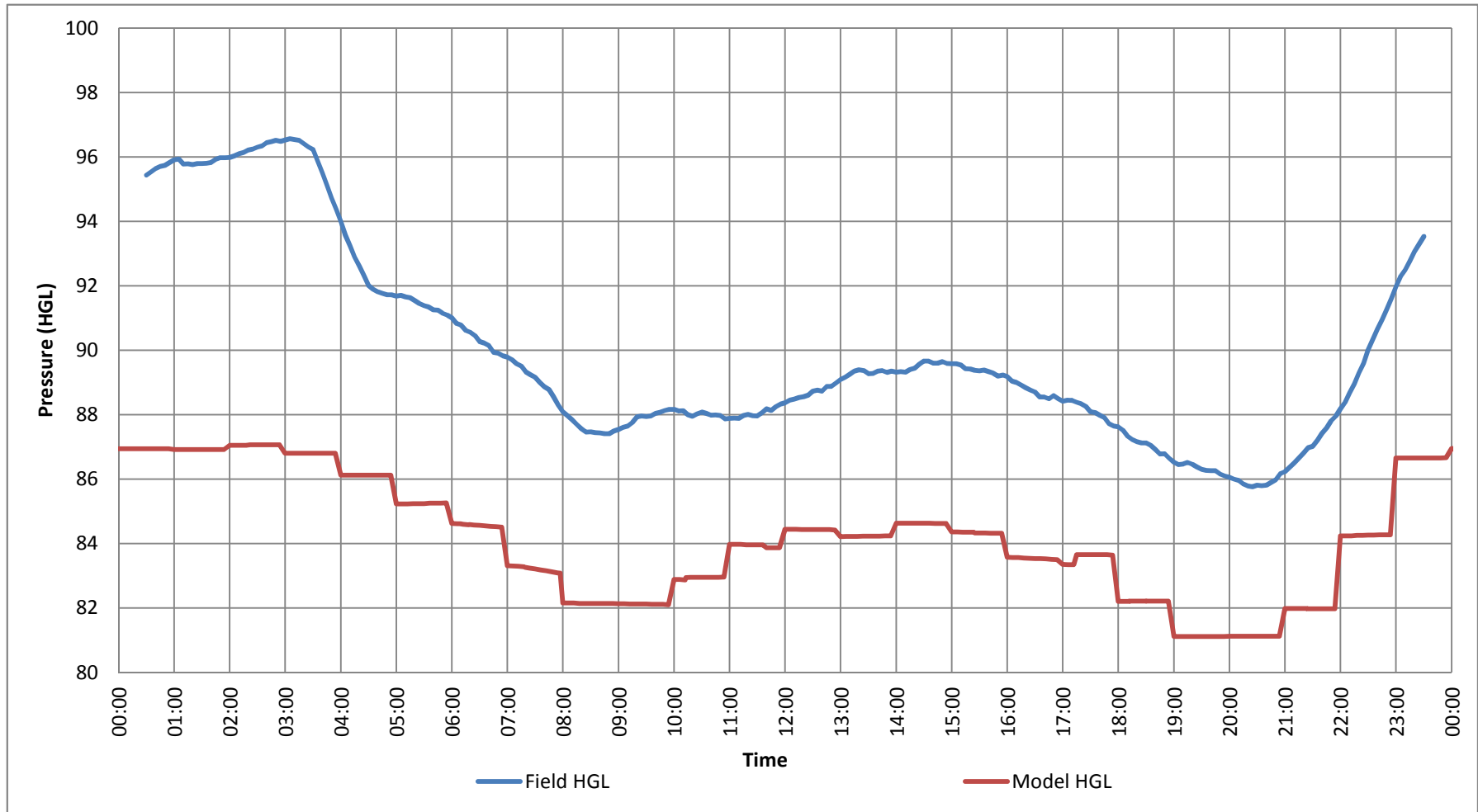

Figure D-8: Site 8 Field vs. Model Data

Zones: 84m Centre Zone

Max Day Demand: 646 L/s

On July, 21, 2013

Location: Site 8 - Laity & 128 Ave.: 128 Ave & 212 Alignment

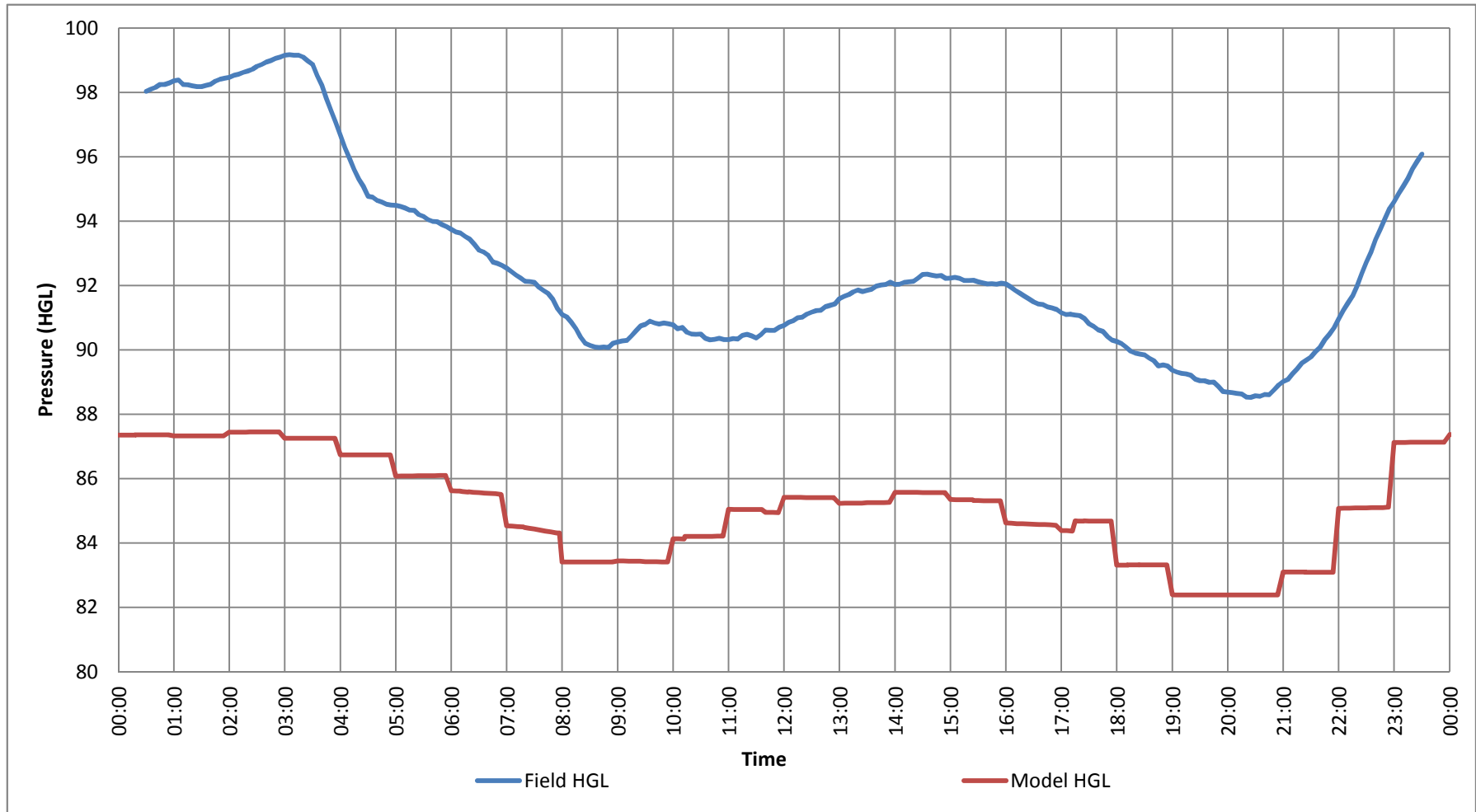

Figure D-9: Site 9 Field vs. Model Data

Zones: 138m Zone

Max Day Demand: 646 L/s

On July, 21, 2013

Location: Site 9 - S241: 12511 241 St

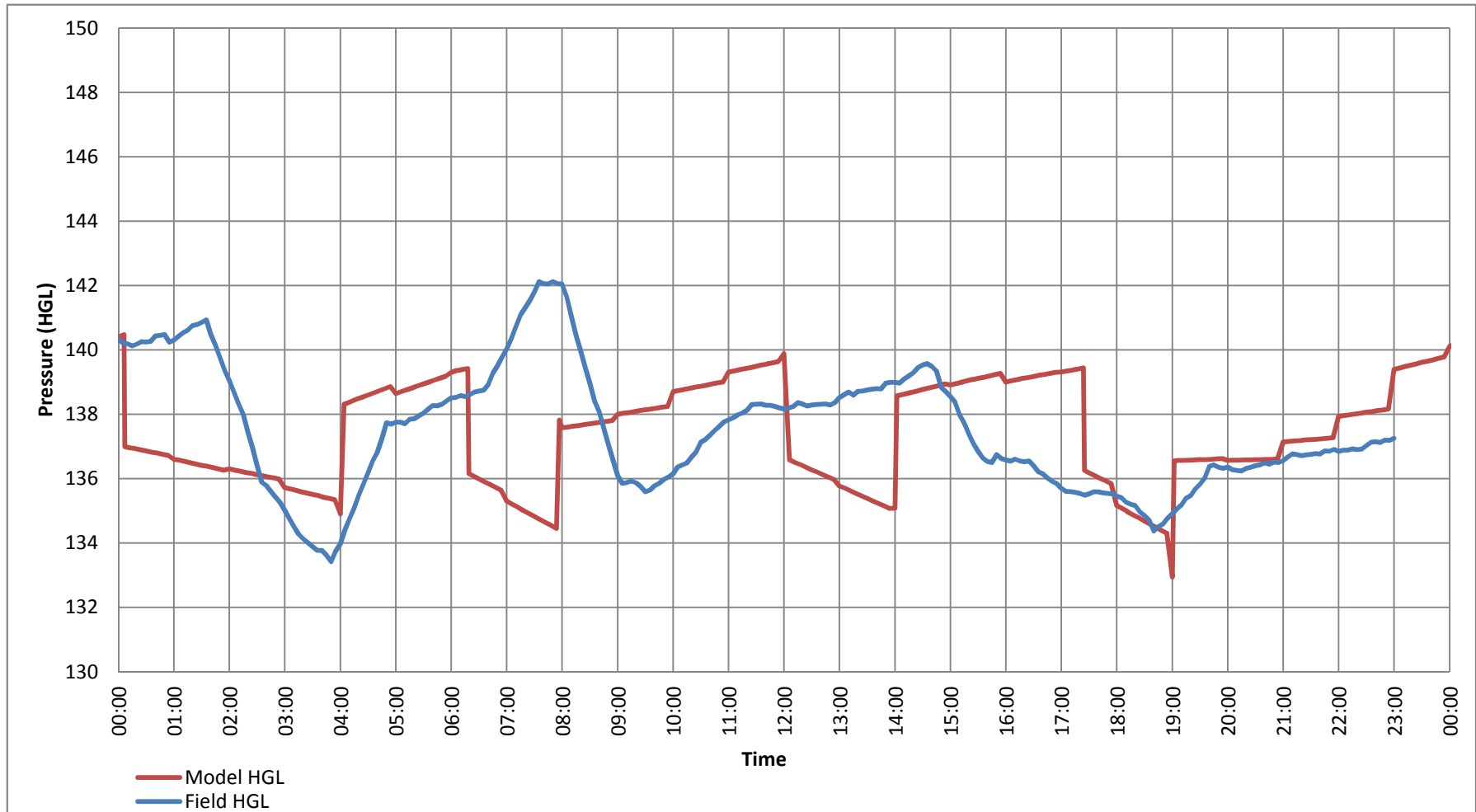

Figure D-10: Site 10 Field vs. Model Data

Zones: 84m Centre Zone

Max Day Demand: 646 L/s

On July, 21, 2013

Location: Site 10 - Tamarack Loop: 23680 108 Loop

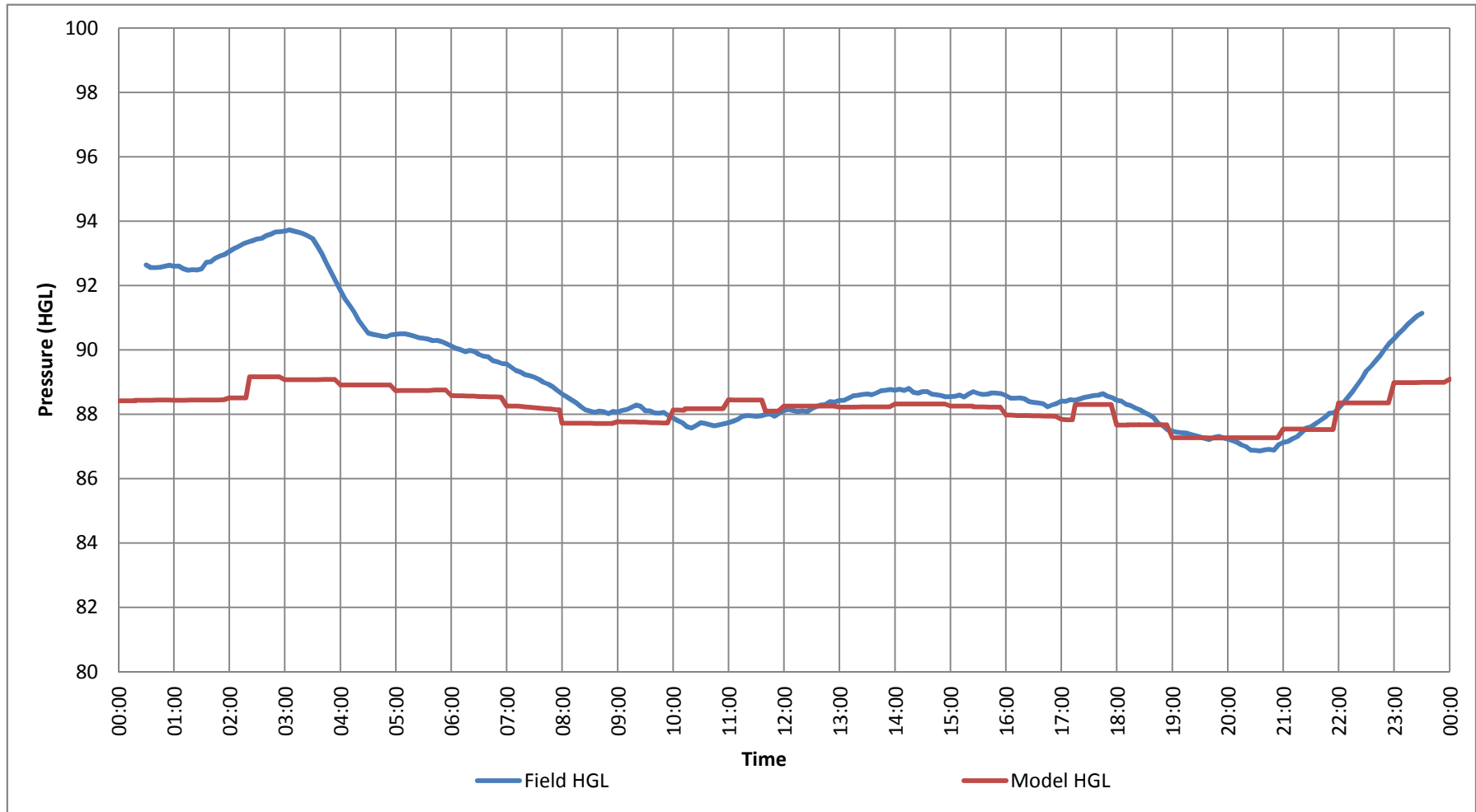

Figure D-11: Site 11 Field vs. Model Data

Zones: 84m Centre Zone

Max Day Demand: 646 L/s

On July, 21, 2013

Location: Site 11 - Fern: 23291 132 Avenue

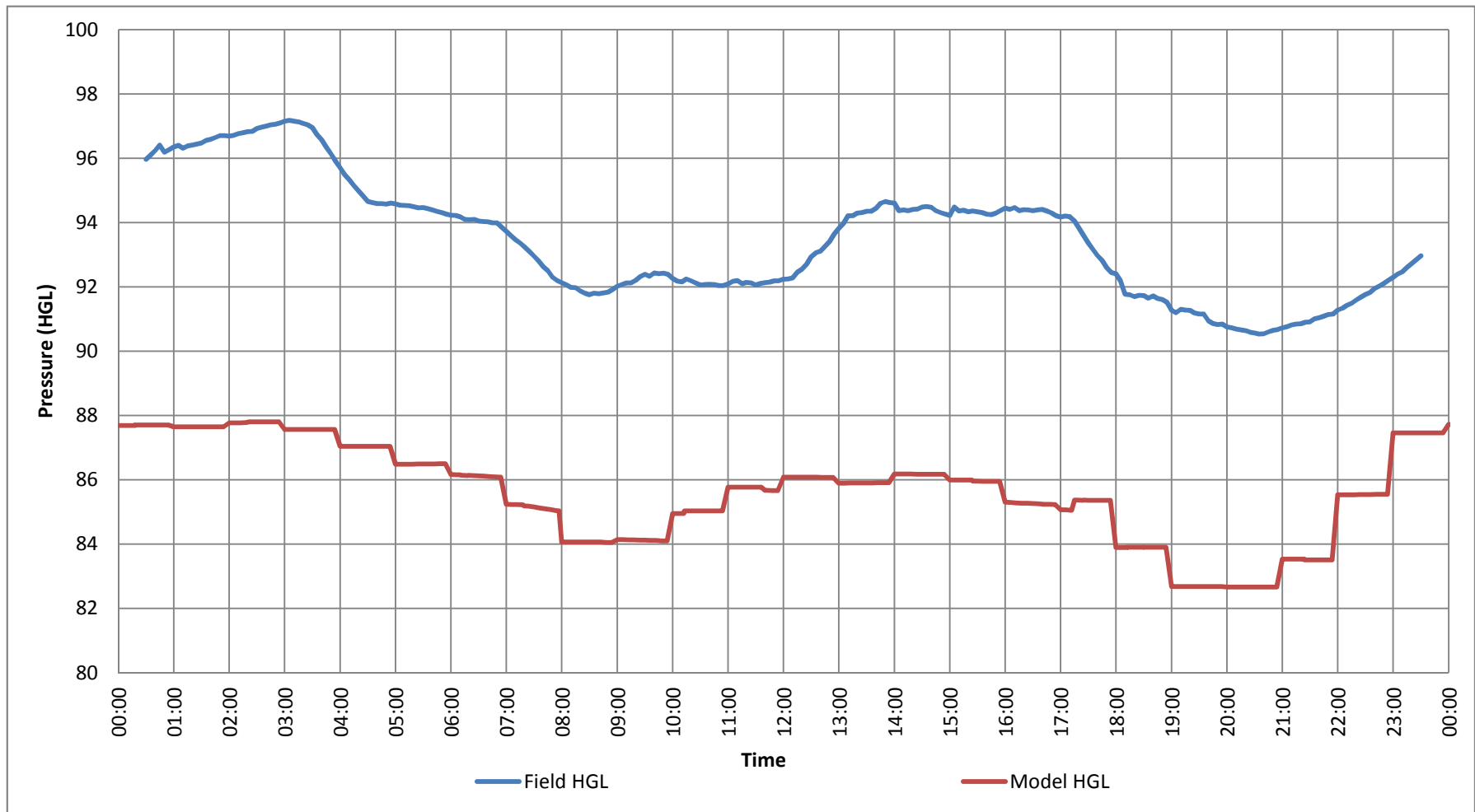

Figure D-12: Site 12 Field vs. Model Data

Zones: 84m Centre Zone

Max Day Demand: 646 L/s

On July, 21, 2013

Location: Site 12 - 236th St.: 11692 236 St.

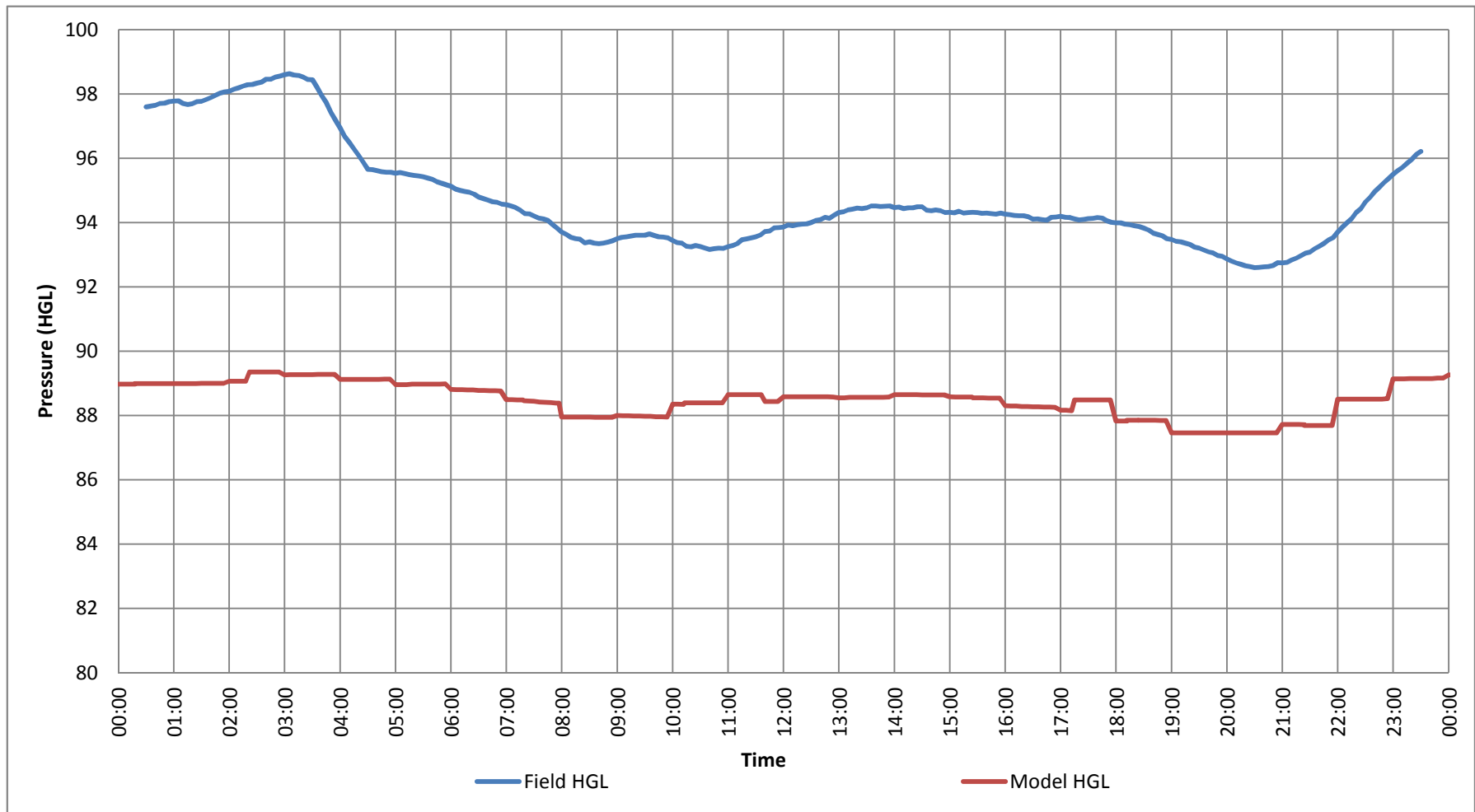

Figure D-13: Site 13 Field vs. Model Data

Zones: 96m Zone

Max Day Demand: 646 L/s

On July, 21, 2013

Location: Site 13 - Nelson Peaks P/S

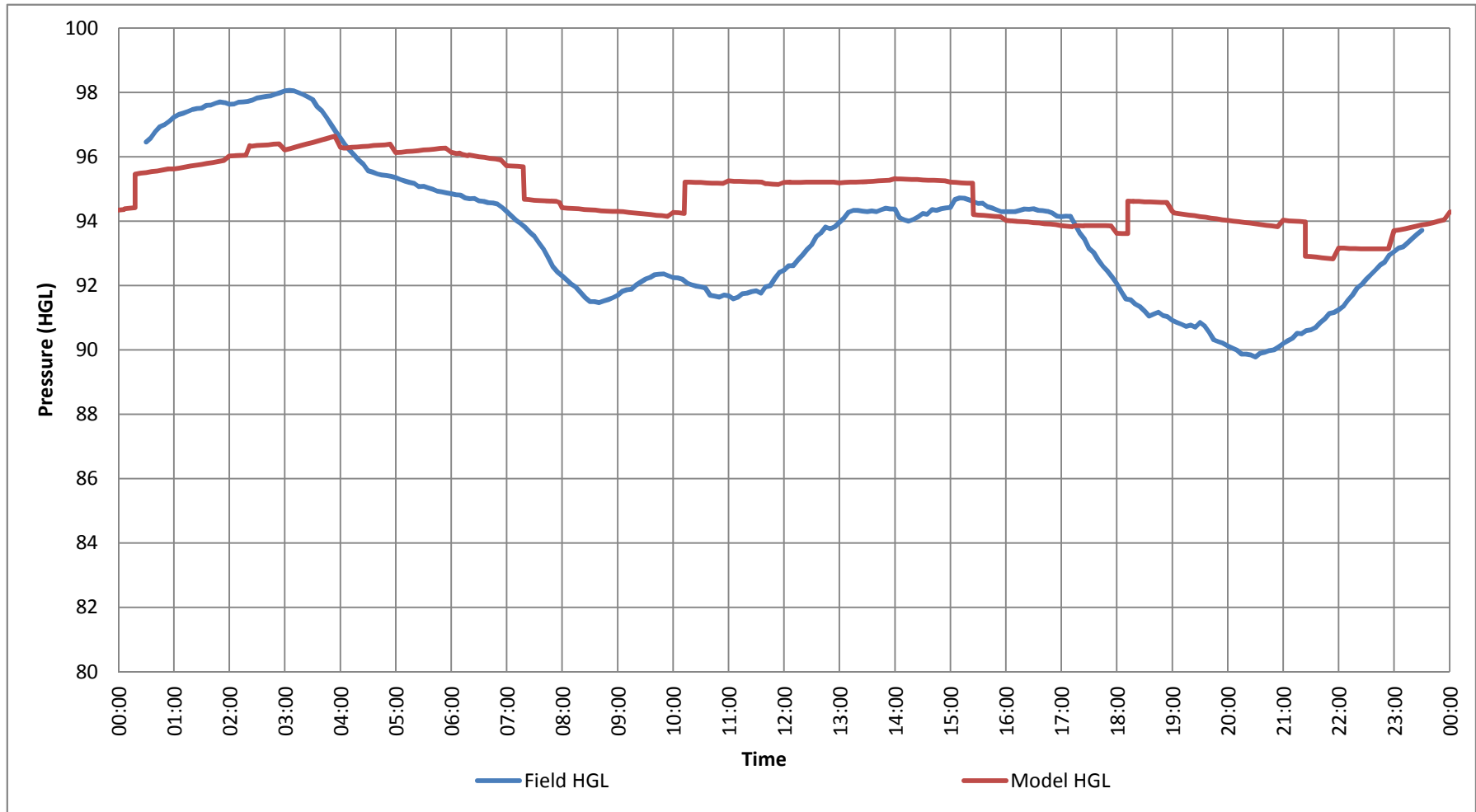

Figure D-14: Site 14 Field vs. Model Data

Zones: Supply

Max Day Demand: 646 L/s

On July, 21, 2013

Location: Albion Pump Station Discharge

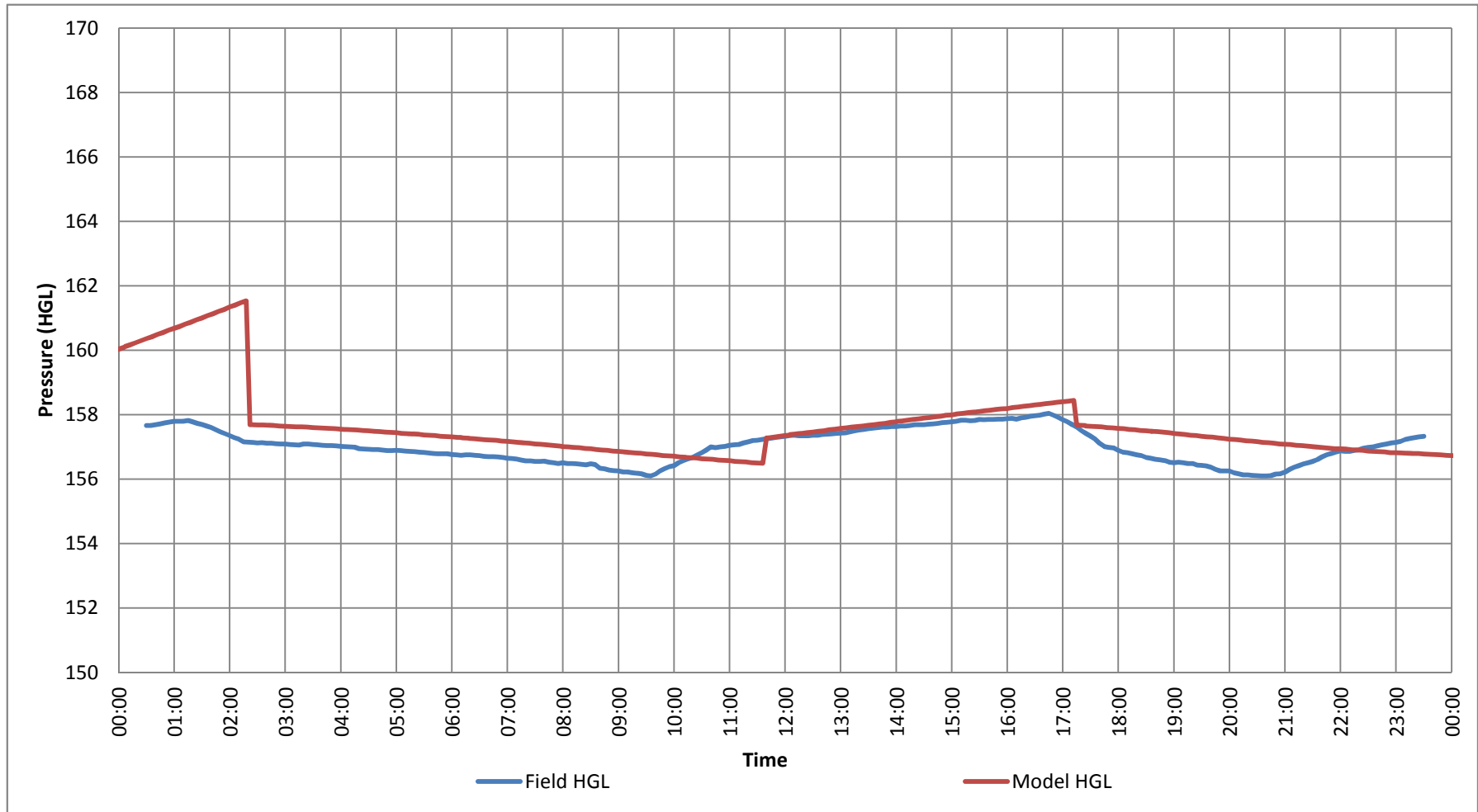

Metro Vancouver Supply Pressure January 2013 at Lougheed Highway and Dewdney Trunk Road

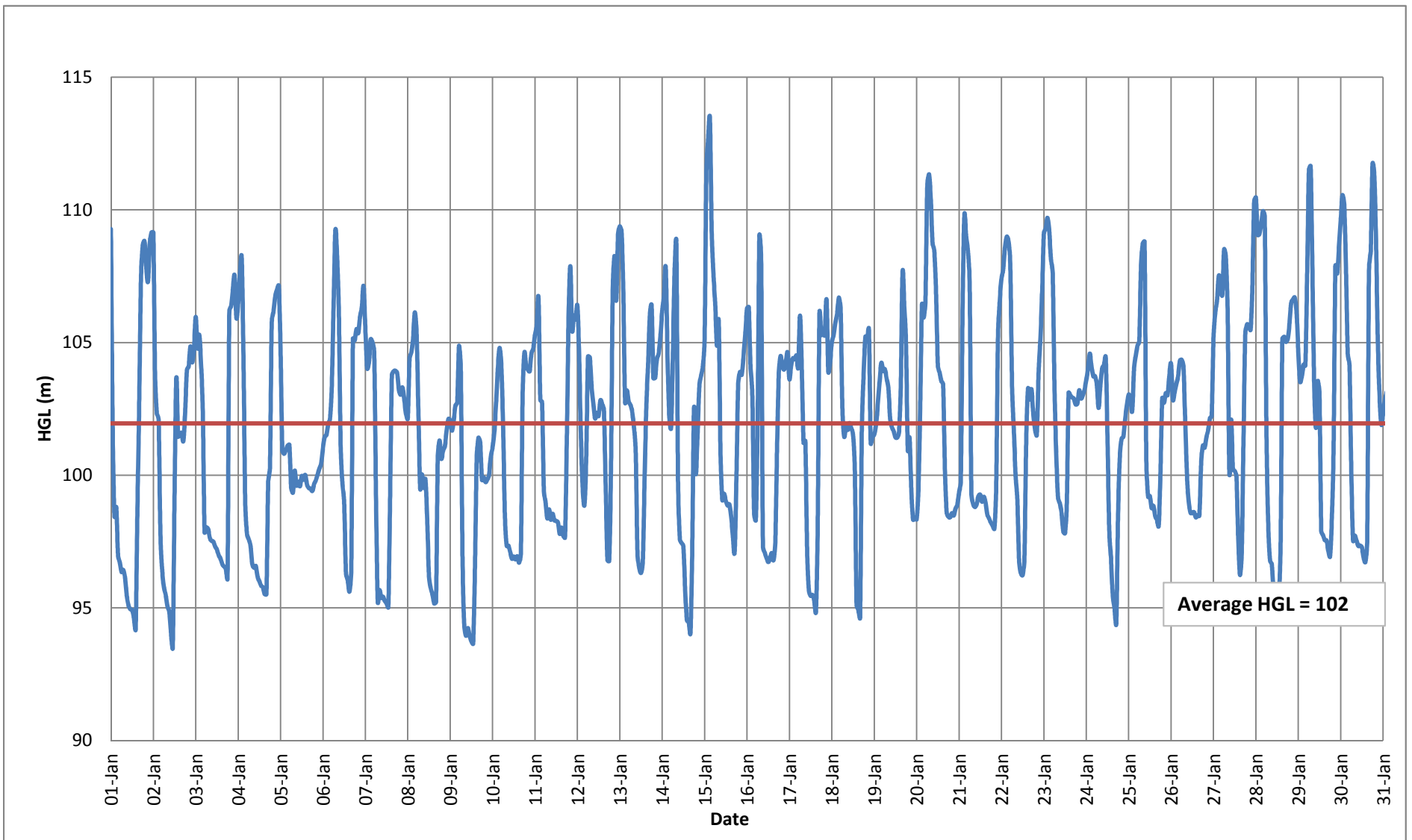

Metro Vancouver Supply Pressure July 24 to 31, 2013 at Lougheed Highway and Dewdney Trunk Road

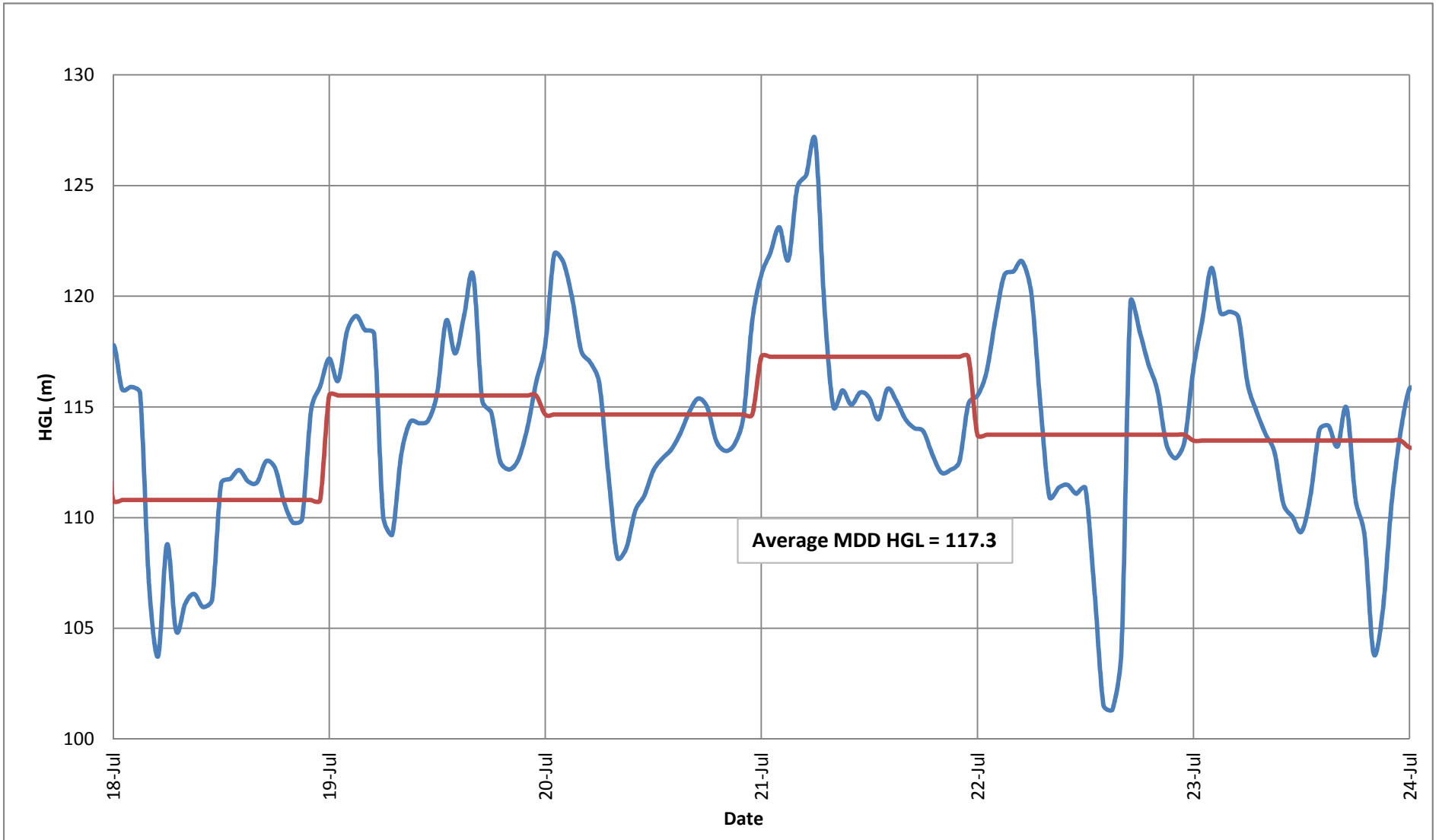



KERR WOOD LEIDAL
consulting engineers

Appendix E

Supply and Storage Sizing Calculations

City of Maple Ridge
 2015 Master Plan Update - Appendix E
 246 Street Pump Station Capacity Assessment

	Parameter A Description	Parameter A	Parameter B Description	Parameter B	Existing (Design)	2018	2023	2041	2041 + Possible Densification	Notes
Min Suction HGL	Elevation (m)	92	Pressure (psi)	0	92.0	92.0	92.0	92.0	92.0	246 St. MV Reservoir - 50% level
Max. Discharge HGL	Elevation (m)	138	Pressure (psi)	0	138.0	138.0	138.0	138.0	138.0	263 St. Reservoir TWL
Piping Friction Losses					3.0	3.0	3.0	3.0	3.0	Assumed loss between suction and discharge locations
Water main Losses					5.0	5.0	5.0	5.0	5.0	
Max. TDH					54.0	54.0	54.0	54.0	54.0	
Service Area Demands (MDD)										
138 m East					78.4	76.3	78.8	88.8	93.1	
224 m Grant Mountain					0.9	4.6	6.4	13.2	13.2	
171 m 130 Ave.					2.8	2.8	2.9	3.4	3.4	
171 m Tretheway					2.6	2.5	2.5	2.5	2.5	
241 m NE					25.1	48.8	60.6	103.5	103.5	
293 m Rothsay					5.7	8.9	10.6	16.9	16.9	
329 m Garibaldi					7.7	12.0	14.9	25.3	25.3	
Flow Requirement:					123.3	156.0	176.7	253.5	257.8	
Existing Capacity					280.0	280.0	280.0	280.0	280.0	
Addl. Flow Capacity Required					- 157	- 124	- 103	- 26	- 22	
Addl. Flow Capacity					-	-	-	-	-	
Addl. Water Power (kW)					-	-	-	-	-	
Addl. BHP (kW)	Pump Efficiency	80%	Pump Oversize Factor	70%	-	-	-	-	-	
Addl. BHP (hp) Duty					-	-	-	-	-	
Recommended additional capacity										

V:\Volumes\0000-0999\0100-0199\173-164\300-Report\WaterMasterPlanReport\Final_Report_Rev3\Appendices\AppE\AppendixE_SupplyStorageCalculations_v3.xlsx|256 & 263 St. PS

KERR WOOD LEIDAL ASSOCIATES LTD.

Consulting Engineers

173.164

City of Maple Ridge
2015 Master Plan Update - Appendix E
236 Street (Silver Valley) Pump Station Capacity Assessment

	Parameter A Description	Parameter A	Parameter B Description	Parameter B	Existing (Design)	2018	2023	2041	2041 + Possible Densification	Notes
Min Suction HGL	Elevation (m)	78	Pressure (psi)	0	78.0	78.0	78.0	78.0	78.0	Minimum suction pressure from 84 m Zone
Max. Discharge HGL	Elevation (m)	176	Pressure (psi)	0	176.0	176.0	176.0	176.0	176.0	Rockridge / SV Reservoir TWL
Piping Friction Losses					3.0	3.0	3.0	3.0	3.0	Assumed loss between suction and discharge locations
Water main Losses					5.0	5.0	5.0	5.0	5.0	
Max. TDH					106.0	106.0	106.0	106.0	106.0	
Service Area Demands (MDD)										
176 m Silver Valley					7.4	16.6	21.4	39.6	39.6	
140 m Lower Silver Valley West					5.6	8.4	9.2	12.5	12.5	
122 m Fern					14.2	17.0	18.9	25.8	30.7	
Flow Requirement:					27.1	42.0	49.5	77.9	82.8	
Existing Capacity					68	68	68	68	68	Firm capacity (one duty pump), fire pump not included
Addl. Flow Capacity Required					- 41	- 26	- 18	10	15	Deficient by 2041
Addl. Flow Capacity					-	-	-	10	15	
Addl. Water Power (kW)					-	-	-	10	15	
Addl. BHP (kW)	Pump Efficiency	80%	Pump Oversize Factor	70%	-	-	-	18	27	
Addl. BHP (hp) Duty					-	-	-	25	37	
Recommended additional capacity								25	40	

/Volumes/0000-0999/0100-0199/173-164/300-Report/WaterMasterPlanReport/Final_Report_Rev3/Appendices/AppE/[AppendixE_SupplyStorageCalculations_v3.xlsx]256 & 263 St. PS

KERR WOOD LEIDAL ASSOCIATES LTD.

Consulting Engineers

173.164

City of Maple Ridge
2015 Master Plan Update - Appendix E
256 Street and 263 Street Pump Station Capacity Assessment

	Parameter A Description	Parameter A	Parameter B Description	Parameter B	Existing (Design)	2018	2023	2041	Notes
Min Suction HGL	Elevation (m)	135	Pressure (psi)	0	135.0	135.0	135.0	135.0	263 St. Reservoir - 50% Level
Max. Discharge HGL	Elevation (m)	241.5	Pressure (psi)	0	241.5	241.5	241.5	241.5	270A Reservoir - TWL
Piping Friction Losses					3.0	3.0	3.0	3.0	Assumed loss between suction and discharge locations
Water main Losses					5.0	5.0	5.0	5.0	
Max. TDH					114.5	114.5	114.5	114.5	
Service Area Demands (MDD)									
171 m 130 Ave.					2.8	2.8	2.9	3.4	
171 m Tretheway					2.6	2.5	2.5	2.5	
241 m NE					25.1	48.8	60.6	103.5	
293 m Rothsay					5.7	8.9	10.6	16.9	
329 m Garibaldi					7.7	12.0	14.9	25.3	
Flow Requirement:					43.9	75.0	91.5	151.5	
Existing Capacity (263 St. PS)					54.0	54.0	54.0	-	Existing capacity not included in 2041 calculation. New 263 St. Pump Station assumed (recommended total capacity accounts for full replacement of existing station).
Existing Capacity (256 St. PS)					42.0	42.0	42.0	42.0	One pump only; assumes largest pump out of service.
Addl. Flow Capacity Required					- 52	- 21	- 4	109	Minimum capacity for replacement 263 St. PS
Addl. Flow Capacity					-	-	-	109	
Addl. Water Power (kW)					-	-	-	123	
Addl. BHP (kW)	Pump Efficiency	80%	Pump Oversize Factor	70%	-	-	-	220	
Addl. BHP (hp) Duty					-	-	-	294	
Recommended total capacity								300	Ultimate 263 Street total capacity of 300 hp (for 110 L/s MDD flow). Accounts for firm capacity at 256 Street Pump Station. Assumes largest pump between the two stations is out of service.

\\Volumes\0000-0999\0100-0199\173-164\300-Report\WaterMasterPlanReport\Final_Report_Rev3\Appendices\AppE\AppendixE_SupplyStorageCalculations_v3.xlsx|256 & 263 St. PS

KERR WOOD LEIDAL ASSOCIATES LTD.

Consulting Engineers

173.164

City of Maple Ridge
2015 Master Plan Update - Appendix E
Albion Pump Station Capacity Assessment

	Parameter A Description	Parameter A	Parameter B Description	Parameter B	Existing (Design)	2018	2023	2041	2041 + Kwantlen	Notes
Min Suction HGL	Elevation (m)	82	Pressure (psi)	0	82.0	82.0	82.0	82.0	82.0	Low suction pressure per model
Max. Discharge HGL	Elevation (m)	158	Pressure (psi)	0	158.0	158.0	158.0	158.0	158.0	Albion Reservoir - TWL 158 m
Piping Friction Losses					3.0	3.0	3.0	3.0	3.0	Assumed loss between suction and discharge locations
Water main Losses					5.0	5.0	5.0	5.0	5.0	
Max. TDH					84.0	84.0	84.0	84.0	84.0	
Service Area Demands (MDD)										
158 m Albion					14.3	24.7	30.1	42.6	42.6	
112 m Albion Subzone					0.9	1.6	2.6	3.4	3.4	
Kwantlen Reserve					-	-	-	-	-	43.0
Flow Requirement:					15.1	26.2	32.7	46.0	89.0	
Existing Capacity					47.0	47.0	47.0	47.0	47.0	From schematic.
Addl. Flow Capacity Required					- 32	- 21	- 14	- 1	42	Upgrades not warranted unless Kwantlen Reserve is ultimately connected and serviced via the Albion Zone.
Addl. Flow Capacity					-	-	-	-	42	
Addl. Water Power (kW)					-	-	-	-	35	
Addl. BHP (kW)	Pump Efficiency	80%	Pump Oversize Factor	70%	-	-	-	-	62	
Addl. BHP (hp) Duty					-	-	-	-	83	
Recommended additional capacity									100	

/Volumes/0000-0999/0100-0199/173-164/300-Report/WaterMasterPlanReport/Final_Report_Rev3/Appencides/AppE/[AppendixE_SupplyStorageCalculations_v3.xlsx]256 & 263 St. PS

City of Maple Ridge
2015 Master Plan Update - Appendix E
270A Street Pump Station Capacity Assessment

	Parameter A Description	Parameter A	Parameter B Description	Parameter B	Existing (Design)	2018	2023	2041	Notes
Min Suction HGL	Elevation (m)	236	Pressure (psi)	0	236.0	236.0	236.0	236.0	270A Reservoir - 50% Full
Max. Discharge HGL	Elevation (m)	329.6	Pressure (psi)	0	329.6	329.6	329.6	329.6	McNutt Rd. Reservoir Full
Piping Friction Losses					3.0	3.0	3.0	3.0	Assumed loss between suction and discharge locations
Water main Losses					5.0	5.0	5.0	5.0	
Max. TDH					101.6	101.6	101.6	101.6	
Service Area Demands (MDD)									
293 m Rothsay					5.7	8.9	10.6	16.9	
329 m Garibaldi					7.7	12.0	14.9	25.3	
Flow Requirement:					13.4	20.9	25.5	42.1	
Existing Capacity					15.1	15.1	15.1	15.1	
Addl. Flow Capacity Required					- 2	6	10	42	
Addl. Flow Capacity					-	6	10	42	
Addl. Water Power (kW)					-	6	10	42	
Addl. BHP (kW)	Pump Efficiency	80%	Pump Oversize Factor	70%	-	10	19	75	
Addl. BHP (hp) Duty					-	14	25	101	
Recommended additional capacity						25	25	150	Upgrade recommended by 2018, Construction of new station recommended by 2041

V:\Volumes\0000-0999\0100-0199\173-164\300-Report\WaterMasterPlanReport\Final_Report_Rev3\Appendices\AppE/[AppendixE_SupplyStorageCalculations_v3.xlsx]270A PS

KERR WOOD LEIDAL ASSOCIATES LTD.

Consulting Engineers

173.164

**City of Maple Ridge
2015 Master Plan Update - Appendix E
Grant Mountain Pump Station Capacity Assessment**

	Parameter A Description	Parameter A	Parameter B Description	Parameter B	Existing (Design)	2018	2023	2041	Notes
Min Suction HGL	Elevation (m)	127	Pressure (psi)	0	127.0	127.0	127.0	127.0	Low suction pressure from 134 m Zone.
Max. Discharge HGL	Elevation (m)	224	Pressure (psi)	0	224.0	224.0	224.0	224.0	Grant Mountain Reservoir - Full
Piping Friction Losses					3.0	3.0	3.0	3.0	Assumed loss between suction and discharge locations
Water main Losses					5.0	5.0	5.0	5.0	
Max. TDH					105.0	105.0	105.0	105.0	
Service Area Demands (MDD)									
224 m Grant Mountain					0.9	4.6	6.4	13.2	
158 m Lower Grant									
Flow Requirement:					0.9	4.6	6.4	13.2	
Existing Capacity					19.0	19.0	19.0	19.0	
Addl. Flow Capacity Required					- 18	- 14	- 13	- 6	
Addl. Flow Capacity					-	-	-	-	
Addl. Water Power (kW)					-	-	-	-	
Addl. BHP (kW)	Pump Efficiency	80%	Pump Oversize Factor	70%	-	-	-	-	
Addl. BHP (hp) Duty					-	-	-	-	
Recommended total capacity									No upgrades identified.

/Volumes/0000-0999/0100-0199/173-164/300-Report/WaterMasterPlanReport/Final_Report_Rev3/Appendices/AppE/[AppendixE_SupplyStorageCalculations_v3.xlsx]256 & 263 St. PS

KERR WOOD LEIDAL ASSOCIATES LTD.

Consulting Engineers

173.164

City of Maple Ridge
2015 Master Plan Update - Appendix E
Forest Pump Station Capacity Assessment

	Parameter A Description	Parameter A	Parameter B Description	Parameter B	Existing (Design)	2018	2023	2041	Notes
Min Suction HGL	Elevation (m)	176	Pressure (psi)	0	176.0	176.0	176.0	176.0	Minimum pressure from 176 m Silver Valley Zone.
Max. Discharge HGL	Elevation (m)	210	Pressure (psi)	0	210.0	210.0	210.0	210.0	Estimated required PH pressure in Forest Zone.
Piping Friction Losses					3.0	3.0	3.0	3.0	Assumed loss between suction and discharge locations
Water main Losses					5.0	5.0	5.0	5.0	
Max. TDH					42.0	42.0	42.0	42.0	
Service Area Demands (MDD)									
210 m Forest Zone					-	2.1	3.9	10.6	
Flow Requirement:					-	2.1	3.9	10.6	
Existing Capacity					-	-	-	-	Area not currently developed.
Addl. Flow Capacity Required					-	2	4	11	
Addl. Flow Capacity					-	2	4	11	
Addl. Water Power (kW)					-	1	2	4	
Addl. BHP (kW)	Pump Efficiency	80%	Pump Oversize Factor	70%	-	2	3	8	
Addl. BHP (hp) Duty					-	2	4	10	
Recommended total capacity						95	95	95	Preliminary sizing for pump station 2x10 hp, plus 75 hp fire pump.

Volumes/0000-0999/0100-0199/173-164/300-Report/WaterMasterPlanReport/Final_Report_Rev3/Appendices/AppE/[AppendixE_SupplyStorageCalculations_v3.xlsx]256 & 263 St. PS

KERR WOOD LEIDAL ASSOCIATES LTD.

Consulting Engineers

173.164

**City of Maple Ridge
2015 Master Plan Update - Appendix E
Thornhill Pump Station #1 Capacity Assessment**

	Parameter A Description	Parameter A	Parameter B Description	Parameter B	2041	Notes
Min Suction HGL	Elevation (m)	90	Pressure (psi)	0	90.0	Minimum pressure from 96 m Centre Sub-zone.
Max. Discharge HGL	Elevation (m)	220	Pressure (psi)	0	220.0	Estimated TWL for future Thornhill Reservoir #1
Piping Friction Losses					3.0	Assumed loss between suction and discharge locations
Water main Losses					5.0	
Max. TDH					138.0	
Service Area Demands (MDD)						
240 m Thornhill					130.6	MDD for entire Thornhill development area
Flow Requirement:					130.6	
Existing Capacity					-	Area not currently developed.
Addl. Flow Capacity Required					131	
Addl. Flow Capacity					131	
Addl. Water Power (kW)					177	
Addl. BHP (kW)	Pump Efficiency	80%	Pump Oversize Factor	70%	316	
Addl. BHP (hp) Duty					423	
Recommended total capacity					600	Preliminary sizing for pump station 4x150 hp, for firm capacity of 450 hp.

N:\Volumes\0000-0999\0100-0199\173-164\300-Report\WaterMasterPlanReport\Final_Report_Rev3\Appendices\AppE/[AppendixE_SupplyStorageCalculations_v3.xlsx]256 & 263 St. PS

KERR WOOD LEIDAL ASSOCIATES LTD.

Consulting Engineers

173.164

**City of Maple Ridge
2015 Master Plan Update - Appendix E
Thornhill Pump Station #2 Capacity Assessment**

	Parameter A Description	Parameter A	Parameter B Description	Parameter B	2041	Notes
Min Suction HGL	Elevation (m)	220	Pressure (psi)	0	220.0	Estimated TWL for future Thornhill Reservoir #1.
Max. Discharge HGL	Elevation (m)	200	Pressure (psi)	0	330.0	Estimated TWL for future Thornhill Reservoir #2.
Piping Friction Losses					3.0	Assumed loss between suction and discharge locations
Water main Losses					5.0	
Max. TDH					118.0	
Service Area Demands (MDD)						
240 m Thornhill					76.0	MDD for all but lower pressure zone (approx. 58% of population)
Flow Requirement:					76.0	
Existing Capacity					-	Area not currently developed.
Addl. Flow Capacity Required					76	
Addl. Flow Capacity					76	
Addl. Water Power (kW)					88	
Addl. BHP (kW)	Pump Efficiency	80%	Pump Oversize Factor	70%	157	
Addl. BHP (hp) Duty					211	
Recommended total capacity					300	Preliminary sizing for pump station 4x75 hp, for firm capacity of 225 hp.

N:\Volumes\0000-0999\0100-0199\173-164\300-Report\WaterMasterPlanReport\Final_Report_Rev3\Appendices\AppE/[AppendixE_SupplyStorageCalculations_v3.xlsx]256 & 263 St. PS

KERR WOOD LEIDAL ASSOCIATES LTD.

Consulting Engineers

173.164

City of Maple Ridge
2015 Master Plan Update - Appendix E
Albion Reservoir Storage Assessment

	Parameter A Description	Parameter A	Parameter B Description	Parameter B	Existing (Design)	2018	2023	2041 (without school)	2041 (with possible school)	Notes
A - Fire Flow Requirement	Fire Flow (L/s)	120	Duration (hr)	2	864	864	864	864	1,080	120 L/s existing, 150 L/s future (if school located within zone)
Service Area Demands (MDD, L/s)										
158 m Albion					14.3	24.7	30.1	42.6	42.6	
112 m Albion Subzone					0.9	1.6	2.6	3.4	3.4	
Flow Requirement (L/s):					15.1	26.2	32.7	46.0	46.0	
B - Balancing Storage (m3)	% of MDD	25%			327	567	706	993	993	
C - Emergency Storage (m3)	% of A+B	25%	A+B	1,191	298	358	392	464	518	
Total Requirement (m3)					1,489	1,788	1,962	2,322	2,592	
Existing Capacity (m3)					1,290	1,290	1,290	1,290	1,290	Albion Reservoir
Available from Grant Mountain Zone					664	564	1,283	1,097	1,097	Grant Mountain fire capacity / oversizing - Capital Project 2015-04 completed in 2016 allows for support from Grant Reservoir. Assumes no simultaneous fire flow demands in Albion/Grant zones.
Total Storage Available to Zone					1,954	1,854	2,573	2,387	2,387	Additional Storage in 2023 onward dependent on construction of 765 cu.m. reservoir at Grant Reservoir site
Storage Deficiency (m³)					- 466	- 66	- 611	- 65	205	2nd Phase of Grant Mtn. Reservoir required to provide excess capacity for Albion by 2023
Additional Pump Capacity (Albion PS)					459	299	206	14	14	
Recommended additional capacity										NOTE: If school constructed, allow additional 205+ cu.m at Grant Mtn site. Recommend that sizing is confirmed in future study.

/Volumes/0000-0999/0100-0199/173-164/300-Report/WaterMasterPlanReport/Final_Report_Rev3/Appendices/AppE/[AppendixE_SupplyStorageCalculations_v3.xlsx]256 & 263 St. PS

KERR WOOD LEIDAL ASSOCIATES LTD.

Consulting Engineers

173.164

City of Maple Ridge
 2015 Master Plan Update - Appendix E
 Rockridge (Silver Valley) Reservoir Storage Assessment

	Parameter A Description	Parameter A	Parameter B Description	Parameter B	Existing (Design)	2018	2023	2041	2041 + Possible Densification	Notes
A - Fire Flow Requirement	Fire Flow (L/s)	150	Duration (hr)	2	1,080	1,080	1,080	1,080	1,080	
Service Area Demands (MDD, L/s)										
176 m Silver Valley and Rockridge					7.4	16.6	21.4	39.6	39.6	
140 m Lower Silver Valley					5.6	8.4	9.2	12.5	12.5	
122 m Fern					14.2	17.0	18.9	25.8	30.7	
Flow Requirement (L/s):					27.1	42.0	49.5	77.9	82.8	
B - Balancing Storage (m³)	% of MDD	25%			586	908	1,069	1,682	1,788	
C - Emergency Storage (m³)	% of A+B	25%			416	497	537	691	717	
Total Requirement (m³)					2,082	2,485	2,687	3,453	3,585	
Existing Capacity (m ³)					4,000	4,000	4,000	4,000	4,000	design/construction of second (2,600 cu.m) tank completed as of 2016
Storage Deficiency (m³)					- 1,918	- 1,515	- 1,313	- 547	- 415	
Recommended additional capacity										

/Volumes/0000-0999/0100-0199/173-164/300-Report/WaterMasterPlanReport/Final_Report_Rev3/Appendices/AppE/[AppendixE_SupplyStorageCalculations_v3.xlsx]256 & 263 St. PS

KERR WOOD LEIDAL ASSOCIATES LTD.
 Consulting Engineers
 173.164

City of Maple Ridge
 2015 Master Plan Update - Appendix E
 263 Street Reservoir Storage Assessment

	Parameter A Description	Parameter A	Parameter B Description	Parameter B	Existing (Design)	2018	2023	2041	2041 + Possible Densification	Notes
A - Fire Flow Requirement	Fire Flow (L/s)	225	Duration (hr)	2.875	2,329	2,329	2,329	2,329	2,329	
Service Area Demands (MDD, L/s)										
138 m East					78.4	76.3	78.8	88.8	93.1	The calculation for demands to the 138 m East Zone are over estimated as compared with recent SCADA information. A future study should be undertaken to further refine the demands in this zone before future capital investments are made. Refer to Urban Systems report "138 m and 241 m Zone Storage and Optimization Study".
Flow Requirement (L/s):					78.4	76.3	78.8	88.8	93.1	
B - Balancing Storage (m3)	% of MDD	25%			1,693	1,648	1,703	1,918	2,011	
C - Emergency Storage (m3)	% of A+B	25%			1,006	994	1,008	1,062	1,085	
Total Requirement (m3)					5,028	4,971	5,040	5,309	5,425	
Existing Capacity (m3)					2,200	2,200	2,200	2,200	2,200	263 St Reservoir
Available from Upper Zones					1,726	3,382	2,936	2,617	2,617	From 256 Reservoirs and 270A St. Reservoirs - note need appropriate PRV's in pump stations to deliver 120 L/s at each location. PRV open/close control required (such as solenoid valve) to close PRVs when pumps are running.
Total Storage Available to Zone					3,925	5,582	5,136	4,817	4,817	Additional Storage in 2018 onward dependent on construction of 1,300 cu.m reservoir at 270A St Reservoir site
Storage Deficiency (m³)					1,102	- 611	- 97	491	607	Storage deficiency in Existing scenario and 2041 can be accommodated by additional 246 St Pump capacity up to 2,250 cu.m and 380 cu.m. respectively
Additional Pump Capacity (246 St PS)					2,257	1,786	1,487	381	319	
Recommended total additional capacity										

\\Volumes\0000-0999\0100-0199\173-164\300-Report\WaterMasterPlanReport\Final_Report_Rev3\Appendices\AppE\AppendixE_SupplyStorageCalculations_v3.xlsx|256 270A St Res

KERR WOOD LEIDAL ASSOCIATES LTD.

Consulting Engineers

173.164

City of Maple Ridge
2015 Master Plan Update - Appendix E
256 Street and 270A Street Reservoir Storage Assessment

	Parameter A Description	Parameter A	Parameter B Description	Parameter B	Existing (Design)	2018	2023	2041	Notes
A - Fire Flow Requirement	Fire Flow (L/s)	225	Duration (hr)	2.875	2,329	2,329	2,329	2,329	
Service Area Demands (MDD, L/s)									
171 m 130 Ave.					2.8	2.8	2.9	3.4	
171 m Tretheway					2.6	2.5	2.5	2.5	
241 m NE (North and South)					25.1	48.8	60.6	103.5	
Flow Requirement (L/s):					30.5	54.1	66.0	109.3	
B - Balancing Storage (m3)	% of MDD	25%			659	1,168	1,426	2,362	
C - Emergency Storage (m3)	% of A+B	25%	A+B		747	874	939	1,173	
Total Requirement (m3)					3,735	4,371	4,693	5,864	
Existing Capacity (m3)					2,532	2,532	2,532	2,532	256 St Reservoirs
Existing Capacity (m3)					600	600	600	600	270A St Reservoir
Available from 329 m Zone						992	869	420	From McNutt Reservoir Fire Storage component, provided PRV connection between zones is constructed
Total Storage Available to Zone					3,132	4,124	4,001	3,552	
Storage Deficiency (m³)					603	247	692	2,312	Storage Deficiency in Existing (Design) and 2018 scenarios can be accommodated by excess pump capacity at 256 St + 263 St.
Additional Pump Capacity (256 St + 263 St PS's)					750	302	65		
Recommended total additional capacity						1,300	1,300	2,600	Long-term: 2 x 1300 cu.m tanks (staged) could be considered, consider locating one at 270 A site. Short-term: one of the two long-term tanks
					1,726	3,382	2,936	2,617	Excess capacity available to lower zones

\\Volumes\0000-0999\0100-0199\173-164\300-Report\WaterMasterPlanReport\Final_Report_Rev3\Appendices\AppE\AppendixE_SupplyStorageCalculations_v3.xlsx\256 270A St Res

KERR WOOD LEIDAL ASSOCIATES LTD.

Consulting Engineers

173.164

**City of Maple Ridge
2015 Master Plan Update - Appendix E
McNutt Road Reservoir Storage Assessment**

	Parameter A Description	Parameter A	Parameter B Description	Parameter B	Existing (Design)	2018	2023	2041	Notes
A - Fire Flow Requirement	Fire Flow (L/s)	60	Duration (hr)	1.4	302	302	302	302	
Service Area Demands (MDD, L/s)									
293 m Rothsay					5.7	8.9	10.6	16.9	
329 m Garibaldi					7.7	12.0	14.9	25.3	
Flow Requirement (L/s):					13.4	20.9	25.5	42.1	
B - Balancing Storage (m3)	% of MDD	25%			290	452	551	910	
C - Emergency Storage (m3)	% of A+B	25%			148	189	213	303	
Total Requirement (m3)					740	943	1,067	1,516	
Existing Capacity					633	633	633	633	
Storage Deficiency (m³)					107	310	434	883	
Recommended total additional capacity						1,000	1,000	1,000	McNutt Reservoir design and construction now underway
					302	992	869	420	Excess capacity available to lower zones

I:\Volumes\0000-0999\0100-0199\173-164\300-Report\WaterMasterPlanReport\Final_Report_Rev3\Appendices\AppE\AppendixE_SupplyStorageCalculations_v3.xlsx|256 & 263 St. PS

KERR WOOD LEIDAL ASSOCIATES LTD.

Consulting Engineers

173.164

**City of Maple Ridge
2015 Master Plan Update - Appendix E
Grant Mountain Reservoir Storage Assessment**

	Parameter A Description	Parameter A	Parameter B Description	Parameter B	Existing (Design)	2018	2023	2041	Notes
A - Fire Flow Requirement	Fire Flow (L/s)	60	Duration (hr)	1.4	302	302	302	302	
Service Area Demands (MDD, L/s)									
224 m Grant Mountain					0.9	4.6	6.4	13.2	
Flow Requirement (L/s):					0.9	4.6	6.4	13.2	
B - Balancing Storage (m3)	% of MDD	25%			20	100	137	286	
C - Emergency Storage (m3)	% of A+B	25%			81	101	110	147	
Total Requirement (m3)					403	503	550	735	
Existing Capacity (m3)					765	765	765	765	
Storage Deficiency (m³)					- 362	- 262	- 215	- 30	
Recommended total additional capacity							765	765	Twin reservoir cell required to meet storage requirements for Albion Zone. The second cell has not been included in the Grant Mountain storage assessment, as it is dedicated entirely to the Albion Zone. NOTE: If school constructed in Albion zone, size increases to +/- 1,000 cu.m. Recommend that sizing is confirmed in future study.

664 564 1,283 1,097 Excess capacity available to lower zones

Volumes/0000-0999/0100-0199/173-164/300-Report/WaterMasterPlanReport/Final_Report_Rev3/Appencides/AppE/[AppendixE_SupplyStorageCalculations_v3.xlsx]256 & 263 St. PS

KERR WOOD LEIDAL ASSOCIATES LTD.

Consulting Engineers

173.164

**City of Maple Ridge
2015 Master Plan Update - Appendix E
Thornhill Reservoir #1 Storage Assessment**

	Parameter A Description	Parameter A	Parameter B Description	Parameter B	2041 + Thornhill	Notes
A - Fire Flow Requirement	Fire Flow (L/s)	150	Duration (hr)	2	1,080	Assumes institutional and/or commercial parcels.
Service Area Demands (MDD, L/s)						
240 m Thornhill					55.0	Estimated demand for lowest pressure zone.
Flow Requirement (L/s):					55.0	
B - Balancing Storage (m3)	% of MDD	25%			1,188	
C - Emergency Storage (m3)	% of A+B	25%			567	
Total Requirement (m3)					2,835	
Existing Capacity (m3)					-	
Storage Deficiency (m³)					2,835	
Recommended total additional capacity					2,850	

Volumes/0000-0999/0100-0199/173-164/300-Report/WaterMasterPlanReport/Final_Report_Rev3/Appendices/AppE/[AppendixE_SupplyStorageCalculations_v3.xlsx]256 & 263 St. PS

KERR WOOD LEIDAL ASSOCIATES LTD.

Consulting Engineers

173.164

**City of Maple Ridge
2015 Master Plan Update - Appendix E
Thornhill Reservoir #2 Storage Assessment**

	Parameter A Description	Parameter A	Parameter B Description	Parameter B	2041 + Thornhill	Notes
A - Fire Flow Requirement	Fire Flow (L/s)	150	Duration (hr)	2	1,080	Assumes institutional and/or commercial parcels.
Service Area Demands (MDD, L/s)						
240 m Thornhill					76.0	Estimated demand for highest three zones.
Flow Requirement (L/s):					76.0	
B - Balancing Storage (m3)	% of MDD	25%			1,642	
C - Emergency Storage (m3)	% of A+B	25%			680	
Total Requirement (m3)					3,402	
Existing Capacity (m3)					-	
Storage Deficiency (m³)					3,402	
Recommended total additional capacity					3,410	

Volumes/0000-0999/0100-0199/173-164/300-Report/WaterMasterPlanReport/Final_Report_Rev3/Appendices/AppE/[AppendixE_SupplyStorageCalculations_v3.xlsx]256 & 263 St. PS

KERR WOOD LEIDAL ASSOCIATES LTD.

Consulting Engineers

173.164



KERR WOOD LEIDAL
consulting engineers

Appendix F

Hydraulic Assessment Notes

Appendix F: Hydraulic Assessment Notes

Note No.	Type	Pressure Zone	Timeline	Description
H-01	Pressure	84 m Centre	Existing	Low peak hour pressure (40 psi) is noted at the end of 126 Avenue east of 238 Street.
H-02	Pressure	84 m Centre	Existing	Low peak hour pressure (43 psi) is noted at the end of 122 Avenue north of 238A Street. Concern is minor and has not been directly addressed in the Master Plan.
H-03	Pressure	112 Albion Sub-zone	Existing	Low peak hour pressure (40 psi) is noted at the bulk filling station on Jackson Road, at the north end of the 245B Street main.
H-04	Pressure	138 m East	Existing	Low peak hour pressure (41 psi) is noted at 248 Street and 124 Avenue. Pressures are improved through implementation of multiple capital projects, not through a single specific project in the Master Plan.
H-05	Pressure	138 m East	Existing	Low peak hour pressure (40 psi) is noted at 248 Street and Marshall Avenue. Pressures are improved through implementation of multiple capital projects, not through a single specific project in the Master Plan.
H-06	Pressure	138 m East	Existing	Low peak hour pressure (38 psi) is noted at Dewdney Trunk Rd. and 260 Street, and east on the feed from the 263 Street Reservoir.
H-07	Pressure	84 m Centre	Future - 2041	Low peak hour pressures are noted in the southeast region of the 84 m Centre Zone. Pressures are improved through implementation of multiple capital projects, not through a single specific project in the Master Plan.
H-08	Pressure	329 m Garibaldi	Future - 2041	Low peak hour pressures become widespread in the 329 m Garibaldi Zone.
H-09	Pressure	84 m Centre	Existing	The existing 240 Street PRV is undersized for PHD based on 2014 field testing (refer to Appendix C for details).
H-10	Pressure	96 m Centre Sub-zone	Existing	Note static pressure is high (163 psi) on Foreman Drive, west of Haley Street.
H-11	Pressure	96 m Centre Sub-zone	Existing	Note static pressure is high (154 psi) on Dockstader Loop, at 138A Avenue.
H-12	Pressure	96 m Centre Sub-zone	Existing	Note static pressure is high (158 psi) at the west end of 134 Loop.
H-13	Pressure	176 m Rockridge	Existing	Note static pressure is high (167 psi) on 235A Street, south of Rockridge Drive.
H-14	Pressure	176 m Rockridge	Existing	Note static pressure is high (160 psi typ.) on 133 Avenue between 236 Street and Bryant Drive.
H-15	Pressure	176 m Rockridge	Existing	Note static pressure is high (155 psi) at 237A Street and 132A Avenue.
H-16	Pressure	241 m NE	Existing	Note static pressure is high (155 – 187 psi) at several locations on 261 Street and 262 Street, between 124 Avenue and 128 Avenue.
H-17	Pressure	241 m NE	Existing	Note static pressure is high (151 psi) at Dewdney Trunk Road and 264 Street.
H-18	Pressure	224 m Grant Mountain	Existing	Note static pressure is high (152 psi) on Bosonworth Avenue, east of 252 Street.
H-19	Pressure	293 m Rothsay	Existing	Note static pressure is high (156 psi) on Rothsay Street, just north of Dewdney Trunk Road.
H-20	Pressure	329 m Garibaldi	Existing	Note static pressure is high (154 psi) at the south end of Kathryn Street, south of Sayers Crescent.
H-21	Fire Flow	84 m Centre	Existing	Fire flow is marginally below design value at the east end of Gilley Avenue, west of Adair Street. Available fire flow = 58 L/s, design fire flow = 60 L/s. No action recommended.
H-22	Fire Flow	84 m Centre	Existing	Fire flow is marginally below design value at the end of 122 Avenue north of 238A Street. Available fire flow = 52 L/s, design fire flow = 60 L/s. Note, this main does not service a hydrant; therefore, no action recommended.
H-23	Fire Flow	84 m Centre	Existing	Fire flow is below design value at the end of 124 Avenue, east of 238 Street. Available fire flow = 56 L/s, design fire flow = 60 L/s. Fire flow will be improved through implementation of multiple capital projects, not through a single specific project in the Master Plan.

Note No.	Type	Pressure Zone	Timeline	Description
H-24	Fire Flow	84 m Centre	Existing	Fire flow is marginally below design value on 241A Street, north of 113 Avenue. Available fire flow = 51 L/s, design fire flow = 60 L/s.
H-25	Fire Flow	84 m Centre	Existing	Fire flow is below design value on Cameron Court, north of 110 Avenue. Available fire flow = 44 L/s, design fire flow = 60 L/s.
H-26	Fire Flow	112 m Albion Sub-zone	Existing	Fire flow is low on 245B Street, north of 104 Avenue. Available fire flow = 55 L/s, 60 L/s design.
H-27	Fire Flow	84 m Centre	Existing	Fire flows are low south of 128 Ave between 235 Street and 239 Street Available fire flow = 32-50 L/s, design fire flow = 60 L/s.
H-28	Fire Flow	84 m	Existing	Fire flow is below design value at the west end of Wharf Street. Available fire flow = 154 L/s, design fire flow = 225 L/s.
H-29	Fire Flow	96 m Centre Sub-zone	Existing	Fire flow is marginally below design value on 136 Avenue east of 229A Street. Available fire flow = 58 L/s, design fire flow = 60 L/s. No action is recommended.
H-30	Fire Flow	84 m Centre	Existing	Fire flow is below design value on 136 Avenue west of Foreman Drive. Available fire flow = 38 L/s, design fire flow = 60 L/s.
H-31	Fire Flow	96 m Centre Sub-zone	Existing	Fire flow is marginally below design value at the east end of the main on Parkside Crescent, north of Anderson Creek Dr. Available fire flow = 58 L/s, design fire flow = 60 L/s. No action is recommended.
H-32	Fire Flow	138 m East	Existing	Fire flow is below design value on 124 Avenue, east of 256 Street. Available fire flow = 37 L/s, design fire flow = 60 L/s. Existing main also long dead-end AC section.
H-33	Fire Flow	138 m East	Existing	Fire flow is marginally below design value on 116 Avenue, east of 260 Street. Available fire flow = 58 L/s, design fire flow = 60 L/s.
H-34	Fire Flow	84 m Centre	Existing	Fire flow is marginally below design value at the south end of Fisherman Dr., south of River Rd. Available fire flow = 169 L/s, design fire flow = 225 L/s.
H-35	Fire Flow	84 m Centre	Existing	Fire flow is marginally below design value on 104 Avenue, west of 242B Street. Available fire flow = 148 L/s, design fire flow = 150 L/s (adjacent to institutional parcel). No action is recommended.
H-50	Fire Flow	84 m Centre	Existing	Fire flow is below design value on 245 Street, north of 104 Avenue. Available fire flow = 135 L/s, design fire flow = 150 L/s.
H-36	Fire Flow	84 m Centre	Future – 2018	Fire flow is marginally below design value on 103A Avenue, west of 242B Street. Available fire flow = 118 L/s, design fire flow = 120 L/s. No action is recommended.
H-37	Fire Flow	84 m Centre	Future – 2018	Fire flow is marginally below design value at 133 Avenue and 133A Avenue. Available fire flow = 119 L/s, required fire flow = 120 L/s. Concern is minor and has not been directly addressed in the Master Plan.
H-38	Fire Flow	84 m Centre	Future – 2018	Fire flow is marginally below design value on 239B Street north of 121 Avenue. Available fire flow = 58 L/s, required fire flow = 60 L/s. No action is recommended.
H-39	Fire Flow	84 m Centre	Future – 2018	Fire flow is below design value near Dewdney Trunk Road and 240 Street. Available fire flow = 56 L/s, design fire flow = 150 L/s. The main appears to be a service and is likely not servicing a fire hydrant; therefore, no action is recommended.
H-45	Fire Flow	84 m Centre	Future – 2023	Fire flow is marginally below design value on 229 Street, north of Purdey Avenue. Available fire flow = 58 L/s, design fire flow = 60 L/s. No action is recommended.
H-46	Fire Flow	84 m Centre	Future – 2023	Fire flow is marginally below design value on Kimola Drive, west of McClure Drive. Available fire flow = 59 L/s, design fire flow = 60 L/s. No action is recommended.
H-47	Fire Flow	84 m Centre	Future – 2041	Fire flows are lower than design value within the industrial area around Kingston Street and 113B Street. Available fire flow = 170 L/s (typical), design fire flow = 225 L/s.

O:\0100-0199\173-164\300-Report\WaterMasterPlanReport\Final_Report_Rev3\Figures_Tables_Appendices\AppendixF_HydraulicAssessmentNotesTable.docx



KERR WOOD LEIDAL
consulting engineers

Appendix G

Detailed Capital Projects Tables

Table G-1: Detailed Capital Projects

Current Project No.	Priority	Source	To Address	Task Name	Description & OCP Sizing	Justification	Timeline		Cost Opinion ¹	Comment
							Short Term	Future Growth		
2015-01	1	138/241 Optimization Study	Performance	270A St. Storage Increase	Construction of 1.3 ML reservoir at site of existing 270A reservoir.	For current emergency storage needs.	✓		\$1,800,000	In addition, future growth will require a further 1.3 ML of storage (could be located at separate site).
2015-02	1	2011 Master Plan	Performance	McNutt Reservoir Expansion	Construction of 0.62 ML reservoir. Siting to be confirmed but tentatively at McNutt Reservoir site.	For current emergency storage needs for the Garibaldi and Rothsay zones.	✓		\$900,000	Future growth will require an additional 0.62 ML of storage.
2015-04	0	2011 Master Plan	Future Growth	108 Avenue Transmission, Grant to Albion Zone PRV	Construct 350 m of new 300 mm dia. DI Watermain connecting the Grant Mountain Reservoir to the Albion Zone PRV Station. Includes 108 Avenue Albion Zone PRV.	Allows Grant Mountain Reservoir to provide back-up fire protection to the Albion Zone.	✓		\$0	Completed as of 2016
2015-06	3	2011 Master Plan	Performance	PRV-240 Upgrade	Existing PRV Station at 240 Street and Dewdney Trunk Rd. (PRV 240) is undersized (300 dia.) for flows conveyed. Project includes upgrading existing PRV Station with new 400 mm dia. PRV and installation of a 100 mm dia. low flow PRV to downstream 500 mm dia. transmission main (approx. 100 m of pipe).	Improve overall PHD pressures to the southern portions of the 84 m Centre zone. Current losses in PRV station > 3m at PHD.	✓		\$200,000	Also part of Albion Flats Water Servicing memo (173.138). Assumes 400 mm dia. PRV can be installed inside the existing chamber.
2015-07	3	2011 Master Plan	Performance	136 Ave. Silver Maples Low Pressure Distribution main looping (232 St. Connection)	220 m of 250 mm dia. to complete loop between Silver Maples and 232 St.	To complete looping of Silver Maples water mains and improve fire flow protection. Development driven.	✓		\$125,000	Per City of Maple Ridge staff, this pipe is now in service.
2015-08	3	2011 Master Plan	Performance	136 Ave. Silver Maples Low Pressure Distribution main looping (224 St. connection)	Approximately 450 m of 200 mm dia. water main between 224 St. and Silver Maples (Foreman Dr.).	To complete looping of Silver Valley water mains, and provide new primary connection to the 84 m Centre Zone.	✓		\$210,000	Connection to 224 St. could be made via the proposed Birdtail development (south of 136 Ave). Project is contingent on conversion of the 96 m Centre Subzone portion of Silver Valley to 84 m Centre Zone.
2015-10	3	2015 Task Development	Future Growth	Extension of the 176 m HGL zone to northwest Silver Valley area	Convert existing 300 mm dia. DI water main on Marc Rd. from 96 m HGL to 176 m HGL. Requires new PRV at Foreman Drive.	Allow for development at higher elevations in northwest Silver Valley.	✓		\$20,000	Conversion of the main can occur at any time; assumes construction of short connection between existing mains at 136 Ave. Completion of Foreman Drive PRV chamber is required prior to pressure change (refer to Project 2015-11).
2015-11	3	2011 Master Plan	Future Growth	Foreman Drive PRV Station	Construction of a new 150 mm PRV Station on Foreman Drive at 232 Ave.	Fire flow / emergency connection from 176 m Rockridge pressure zone to proposed 84 m Centre in Silver Valley.	✓		\$75,000	Buried chamber is already installed; installation of internal piping/valves is required to complete station.
2015-12	3	2015 Task Development	Future Growth	Marc Rd. Water Main Extension	Construction of approximately 200 m of 300 mm dia. water main on Marc Rd to 141 Ave.	Allow for initial development along Marc Rd.	✓		\$115,000	Ultimately, mains on Marc Rd. and Silver Valley Rd. are intended to connect via 141 Ave. Consider extension on Marc Rd. as land use change driven project. Ultimately useful for looping from 176 m pressure zone.
2015-13	3	2015 Task Development	Future Growth	270A Pump Station	Upgrade 270a PS. Preliminary pump sizing 2x60HP (includes one standby).	To meet future demands of the 293 m and 329 m zones.	✓		\$120,000	Demand projections suggest that existing station is nearing capacity.
2015-14	4	2011 Master Plan	Performance	112 Ave. Loop to 110 Ave.	330 m of 150 mm dia. DI main looping between dead-end mains on 112th Ave. to Cameron Court (& 110th Ave.) east of 240 St.. New right-of-way through private property required.	Improve fire flows, reliability and water quality (by provision of loop).	✓		\$140,000	City composite pipe map shows no pipe. Consider as land use change driven project.
2015-15	4	2011 Master Plan	Performance	Looping of 238 St. & 126 Ave. to 239 Street	210 m of 150 mm DI pipe to complete water main loop at existing dead-ends.	Improve fire flows provided, provide looping for water quality & reliability of supply.	✓		\$150,000	City composite pipe map shows no pipe. Cost includes underground creek crossing. A water quality assessment should be completed before construction of a looped connection.
2015-16	4	2011 Master Plan	Performance	260 St. Watermain Upgrades	Replace existing 150 mm dia. 1971 AC water main (450 m long) with 200 mm DI.	Improve fire flows, replace AC water main.	✓		\$200,000	City composite pipe maps shows AC pipe.
2015-17	4	2015 Task Development	Performance	245B St. PRV Setting	Modify 150 mm dia. PRV set point to 115 m HGL (note, 50 mm dia. PRV set point assumed to be kept 10 psi higher).	Improve available fire flow at north end of 245B St.	✓		Nominal	Main services a bulk water fill station. Low FF value (57 L/s) at cul-de-sac (hydrant located here).

1. Cost opinions include contingency and engineering, but exclude land acquisition and easement costs

Current Project No.	Priority	Source	To Address	Task Name	Description & OCP Sizing	Justification	Timeline		Cost Opinion ¹	Comment
							Short Term	Future Growth		
2015-18	4	2015 Task Development	Performance	241A St. Water Main Looping	Installation of approximately 350 m of 200 mm dia. water main. Requires new SROW at north end of 241A St.	Improve available fire flow on 241A St.	✓		\$160,000	Constricted by creek to south of 241 St. Limited options for looping; cannot connect at 240A St. due to position of existing homes. Consider as land use change driven project.
2015-19	4	2011 Master Plan	Future Growth	Grant Mountain Reservoir Cell #2	Addition of a new, 765 m ³ cell to the Grant Mountain reservoir.	Addresses Albion Zone fire flow storage shortfall, including future demands.	✓		\$1,100,000	Existing reservoir site layout includes space and connections for second cell.
2015-20	5	2011 Master Plan	Performance	Backflow Prevention – Top of Garibaldi Zone	Installation of backflow prevention on residential services at top of the 329 m Garibaldi Zone, estimated 10 services total.	Reduce cross-connection hazard. Specifically addresses cross-connection risk during fire flows in Zone.	✓		\$20,000	Mitigates contamination risk due to low pressures at highest lot elevations.
2015-22	5	2011 Master Plan	Performance	River Road Seismic Event Automatic Isolation Valves	Construction of three valve chambers at: - Lougheed Highway and Haney Bypass, - Tamarack Lane and Lougheed Hwy. - 240 St. and Lougheed Hwy.	Automatically isolate seismically vulnerable section of River Road from the rest of the water system in the case of seismic breakage. River Rd. water main is particularly susceptible to breaks due to liquefiable soils. See River Road Seismic Assessment report (KWL File 173.131)	✓		\$1,000,000	May be evaluated as part of larger city-wide study investigating other areas with seismically vulnerable pipes. Priority for River Rd. may be dictated by outcome of study.
2015-23	5	2015 Task Development	Performance	Fisherman Rd. Looping	Upsizing of approximately 450 m of existing 200 mm dia. water main to 250 mm dia. on Fisherman Rd. and McKay Ave.	Improve available fire flow at existing industrial developments on Fisherman Rd.	✓		\$225,000	Options for looping are limited. Consider as land use change driven project.
2015-24	5	2015 Task Development	Performance	124 Ave. Water Main Looping	Installation of approximately 800 m of 200 mm dia. water main from 124 Ave. to Dewdney Trunk Rd.	Improve available fire flow on 124 Ave.	✓		\$360,000	Limited options for looping. Water main ends at boundary between 138 m East and 241 m NE zones. Consider as land use change driven project.
2015-26	3	2015 Task Development	Future Growth	232 Street PRV Station	Installation of a PRV station at or near the intersection of 232 Street and 136 Avenue, connecting the 96 m Centre Subzone to the 84 m Centre Zone.	Provides a redundant connection to the portion of Silver Valley to be serviced by the 84 m Centre Zone.	✓		\$200,000	Related to project 2015-08 (direct connection to 84 m Centre Zone at 136 Avenue and 224 Street)

1. Cost opinions include contingency and engineering, but exclude land acquisition and easement costs

Current Project No.	Previous Project ID	Source	Required For	Task Name	Description & OCP Sizing	Justification	Timeline		Cost Opinion ¹	Comment
							Short Term	Future Growth		
2015-25	23	2011 Master Plan	Future Growth	Upgrade 236 Street Pump Station	Add additional 40 HP pumping capacity to existing station.	Increase firm capacity of station to 80 L/s to meet build-out demand.		✓	\$260,000	Assumes existing station can be modified to accommodate additional pump. An alternative option would be to directly pump into lower zones rather than through the Rockridge Reservoir, by upgrading the 232 Street Pump Station to provide domestic and fire flows to the 140 m Lower Silver Valley Zone.
2015-27	59	2011 Master Plan	Future Growth	McNutt Road to Garibaldi St. Looping	Approximately 220 m of 200 mm DI water main connecting the McNutt Road Supply main to the development	Meet fire flow requirements in combination with future demands, improve water circulation in zone		✓	\$110,000	Fire flows improve from roughly 60 L/s to >120 L/s. However, the area is zoned for single family residential, therefore >60 L/s not required. Does improve looping and redundancy though.
2015-29	103	2011 Master Plan	Future Growth	256 St Watermain Upgrade	Twin existing water main on 256 St., north of DTR to 256 St. Pump Station with 1600 m of 300 mm dia DI water main	Improve flow rate and supply reliability to 256 St. Pump Station and downstream zones, to accommodate future demands		✓	\$910,000	Not required to meet specific fire flow deficiency. However, does improve redundancy.
2015-30	104	2011 Master Plan	Future Growth	269 Street and 270 Street Watermain Upgrades	Twin existing water main on 269 St. and 270 St., north of DTR to the 270A Reservoir, with 1010 m of 300 mm dia DI water main as dedicated transmission.	Improve flow rate and supply reliability to 270A St Reservoir, including future demands.		✓	\$575,000	Not required to meet specific fire flow deficiency. However, does improve redundancy.
2015-31	105	2011 Master Plan	Future Growth	270A Pump Station to McNutt Road Watermain Upgrades	Twin existing water main between 270A Pump Station to McNutt Road, with 660 m of 300 mm dia. DI water main	Improve flow rate and supply reliability to Garibaldi and Rothsay pressure zones, including future demands		✓	\$380,000	Not required to meet specific fire flow deficiency. However, does improve redundancy.
2015-32	109	2011 Master Plan	Future Growth	112 Avenue Transmission, Albion Zone PRV to 248 Street	Construct 360m of new 300 mm dia. DI Watermain connecting the Albion Zone PRV Station from Grant Mountain to Albion Distribution system at 248 Street	Allows Grant Mountain Reservoir to provide back-up fire protection to the Albion Zone		✓	\$215,000	Provides redundancy, not required for a specific deficiency.
2015-33	113	2011 Master Plan	Future Growth	263 Street Pump Station Expansion	Construction of a new 263 St. pump station, tentatively sized for 300 hp. See KWL technical memorandum of March 4, 2010 (file 173.135-300) for details of the previous pump station assessment.	To meet future demands. Sized to work in conjunction with firm capacity at 256 Street Pump Station (i.e. one pump out of service at 256 Street, all pumps operating at 263 Street).		✓	\$2,500,000	Considers existing capacity at 256 St. Pump Station.
2015-35	116	2011 Master Plan	Future Growth	241m NE Zone Reservoir Expansion	Installation of final 1,300 m3 of storage capacity for 241 m NE Zone.	To address future balancing and fire protection needs for the 241 NE zone and Garibaldi zone.		✓	\$1,800,000	Could be installed at existing 270A Reservoir site or at a separate location.
2015-36	119	2011 Master Plan	Future Growth	136 Ave Rockridge Zone Looping	Construction of 1050 m of new 200 mm dia water main connecting 236 Street and 240 Street ROW via 136 Ave.	Extend serviced region of system. Improved water quality and reliability in Rockridge zone.		✓	\$500,000	Extending 136 Ave main further west would required PRV to 140 m zone. See project 2015-40.
2015-37	120	2011 Master Plan	Future Growth	Forest Pump Station	Construction of new 90 HP pump station (2x10 HP duty pumps + 75 HP fire pump) to supply new Forest Zone	Extend serviced region of Silver Valley area.		✓	\$1,000,000	Anticipated to be the last area of SV to be developed.
2015-44	New	2015 Task Development	Future Growth	New Pipeline to Thornhill Pump Station	Install roughly 4,300 m of 400 mm dia. water main on 240 St. and 104 Ave.	To convey 96 m HGL to proposed Thornhill Pump Station.		✓	\$2,700,000	Pipe alignment to be confirmed. Consideration should be given to sizing the main to also service Albion Flats and/or Kwantlen First Nation.
2015-45	New	2015 Task Development	Future Growth	New Thornhill Pump Station	Construction of new 131 L/s capacity pump station to service Thornhill MDD buildout. Potentially phased pump installation dependent on pace of growth.	To service Thornhill buildout area. Approximately 600 HP pump station.		✓	\$4,100,000	Assumes MDD for Thornhill will be pumped from 96 m zone to reservoir with TWL 220 m.
2015-46	2	Albion Flats Water Servicing	Future Growth	104 Ave - Slatford Place to 240 St.	Replace 170 m of 200 mm dia. main with 250 mm dia.	Previously recommended in River Road Seismic Assessment (173.131). Needed for proper servicing of Albion Flats.		✓	\$100,000	Related to Albion Flats Densification.
2015-50	81	2011 Master Plan	Future Growth	128 Avenue to Dogwood Avenue Looping	410 m of 200 mm dia. from Dogwood Ave. to 128 Cr.	Improve fire flow protection locally & looping to improve water quality and reliability for both Dogwood Ave. and 128 Ave. areas.		✓	\$200,000	Fire flows at east end of 128 Ave. and to south are marginally deficient in future. Consider as land use change driven project.
2015-51	4	2015 Task Development	Future Growth	270A St. Pump Station Increase	Construct new pump station, tentatively 210 hp.	Existing firm capacity of station is 12 L/s; for OCP buildout, design firm capacity is 42 L/s.		✓	\$2,100,000	0
2015-52	New	2015 Task Development	Future Growth	Thornhill Reservoir #1 Supply Main	Construct approximately 1,400 m of 400 mm dia. water main between the proposed primary Thornhill Pump Station and the proposed Thornhill Reservoir.	To convey the total Thornhill MDD (131 L/s) to the development area.		✓	\$940,000	Assumes 104 Ave. alignment.
2015-53	New	2015 Task Development	Future Growth	Thornhill Reservoir #1	Construct approximately 2.85 ML of storage at elevation 220 m.	To provide balancing, fire, and emergency storage for the serviced area of the Thornhill Urban Reservoir below approximately elevation 180 m.		✓	\$2,500,000	A reservoir siting study is required to determine optimal number and location of reservoirs required.
2015-54	New	2015 Task Development	Future Growth	Thornhill Secondary Pump Station	Construct a new 300 hp pump station to supply the upper Thornhill servicing area, by filling future Thornhill Reservoir #2. Preliminary design flow for station is 76 L/s.	For filling the proposed Thornhill Reservoir #2 (approximate TWL 330 m).		✓	\$2,100,000	-

1. Cost opinions include contingency and engineering, but exclude land acquisition and easement costs

Current Project No.	Previous Project ID	Source	Required For	Task Name	Description & OCP Sizing	Justification	Timeline		Cost Opinion ¹	Comment
							Short Term	Future Growth		
2015-55	New	2015 Task Development	Future Growth	Thornhill Reservoir #2 Supply Main	Construct approximately 1,800 m of 300 mm dia. water main between the proposed Thornhill Secondary Pump Station and Thornhill Reservoir #2.	To convey the MDD (76 L/) for the developable area of Thornhill above elevation 180 m.		✓	\$1,020,000	-
2015-56	New	2015 Task Development	Future Growth	Thornhill Reservoir #2 (Servicing Upper Pressure Zones)	Construct approximately 3.41 ML of storage at elevation 330 m.	To provide balancing, fire, and emergency storage for the serviced area of the Thornhill Urban Reservoir above approximately elevation 180 m.		✓	\$3,000,000	-
2015-57	New	2015 Task Development	Future Growth	Thornhill On-Site PRV Stations	Construction of six PRV stations, to supply intermediate pressure zones below proposed Thornhill Reservoir #2 and above servicing elevation of proposed Thornhill Reservoir #1, as well as for the lowest elevations in the Reservoir #1 servicing area.	To allow for creation of stepped pressure zones within the Thornhill Area.		✓	\$1,200,000	Total number of PRV stations, valve sizing, and locations would be determined during predesign for Thornhill water servicing.
2015-58	New	2015 Task Development	Future Growth	240 St. and 104 Ave. PRV Station	Construction of a PRV station at the south end of the proposed 96 m HGL transmission main on 240 Street.	Addition of a PRV station will offset demands from the existing 84 m HGL transmission main on 240 Street, and improve flows to the proposed Albion Flats area.		✓	\$200,000	-
2015-59	New	2015 Task Development	Future Growth	Albion Flats Water Main	Construction of approximately 2,400 m of 300 mm dia. water main between Tamarack Lane and 240 Street.	Forms the backbone for fire flow through the possible Albion Flats area.		✓	\$1,360,000	Boundary of the Albion Flats area is subject to change; future study required to confirm water main locations.
2015-60	New	2015 Task Development	Future Growth	KFN Feeder Main	Construction of approximately 75 m of 250 mm dia. water main on 248 Street between 100 Avenue and the KFN boundary.	To convey 43 L/s MDD to KFN from the existing Albion zone.		✓	\$50,000	-
2015-61	New	2015 Task Development	Future Growth	Albion Pump Station Capacity Increase for KFN	Increase the firm capacity of the existing Albion Pump Station by 43 L/s.	The capacity increase will account for the estimated MDD demand for KFN.		✓	\$450,000	Project identified in KWL memo 173.142.
2015-62	New	2015 Task Development	Future Growth	Wharf Street Water Main Upsizing	Construction of approximately 460 m of 300 mm water main to replace existing 200 mm main. Replacement main to be installed starting at Hazelwood Street to west end of Wharf Street.	Upsizing the main will allow for industrial fire flow (225 L/s) to be achieved at the west end of Wharf Street.		✓	\$270,000	Fire flows could instead be improved by looping through the industrial parcels north of Wharf Street. Actual project should be confirmed with a servicing review.

/Volumes/0000-0999/0100-0199/173-164/300-Report/WaterMasterPlanReport/Final_Report_Rev3/Appendices/AppG/[AppendixG_DetailedCapitalProjectsTablesV1.xlsx]AppG-2

1. Cost opinions include contingency and engineering, but exclude land acquisition and easement costs



KERR WOOD LEIDAL
consulting engineers

Appendix H

Maple Benchlands Area

